



INSTRUCTION MANUAL

Types 1521-B, -BQ1
Graphic Level
Recorders

GENERAL RADIO

Contents

SPECIFICATIONS
CONDENSED OPERATING INSTRUCTIONS
INTRODUCTION – SECTION 1
INSTALLATION – SECTION 2
OPERATING PROCEDURE – SECTION 3
PRINCIPLES OF OPERATION – SECTION 4
APPLICATIONS – SECTION 5
SERVICE AND MAINTENANCE – SECTION 6

Handbook of Noise Measurement

This 282-page book, by Dr. A. P. G. Peterson and Ervin E. Gross, Jr., of the General Radio Engineering Staff, covers thoroughly the subject of noise and vibration measurement. Copies are available from General Radio at \$2.00 each, postpaid in the United States and Canada.

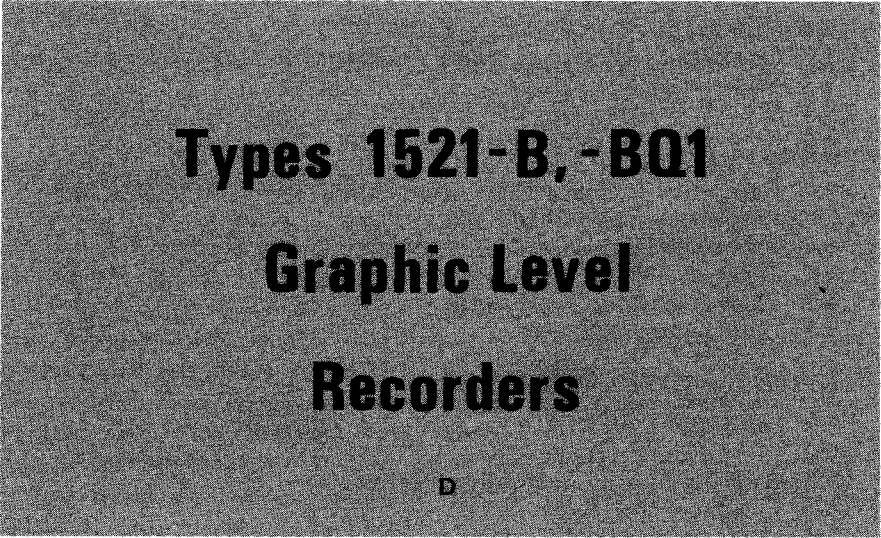

Types 1521-B, -BQ1 Graphic Level Recorders

D

© GENERAL RADIO COMPANY 1964

West Concord, Massachusetts U.S.A. 01781

Form 1521-0150-D

ID-2528

March, 1969

TABLE OF CONTENTS

Section 1	INTRODUCTION	
	1.1 Purpose	1
	1.2 General Description	2
	1.3 Writing Speed	2
	1.4 Paper Speed	2
	1.5 Accessories	2
Section 2	INSTALLATION	
	2.1 General	5
	2.2 Level-vs-Frequency Recording	8
	2.3 Dc Recording	9
	2.4 Stacking	9
Section 3	OPERATING PROCEDURE	
	3.1 Controls	10
	3.2 General Operation	10
	3.3 Level-vs-Time Recording	13
	3.4 Level-vs-Frequency Recording	13
	3.5 Dc Recording	15
Section 4	PRINCIPLES OF OPERATION	
	4.1 General	16
	4.2 Input Circuit and Ac Amplifier	16
	4.3 Detector	16
	4.4 Pen Drive Circuit	16
	4.5 Velocity Feedback	17
	4.6 Logarithmic Potentiometers	17
	4.7 Dc Recording	17
	4.8 Transient Response and Dynamic Error	17
	4.9 Accuracy of Null (Static Accuracy)	20
	4.10 Servo Bandwidth	21
	4.11 High-Q Analyzers	22
Section 5	APPLICATIONS	
	5.1 General	23
	5.2 Use with Sound-Level Meter	23
	5.3 High-Level Sounds	24
	5.4 Vibration Level vs Time	24
	5.5 Reverberation Time and Decay Rate	25
	5.6 VU Recordings	28
	5.7 Frequency Response Measurements Using Type 1304-B Beat-Frequency Audio Generator	28
	5.8 Frequency-Response Measurements of Phonograph	28
	5.9 Constant Sound-Pressure Level	28
	5.10 Direct Comparison Levels	31
	5.11 Frequency Analysis	32
Section 6	SERVICE AND MAINTENANCE	
	6.1 General	33
	6.2 Cleaning and Lubrication	33
	6.3 Overshoot and Creep Adjustments	33
	6.4 Trouble-Shooting Procedure	35
	6.5 Other Service Problems	35
	6.6 Minimum Performance Standards	36
	6.7 Knob Removal	38
	6.8 Knob Installation	38
	6.9 Motor Replacement	39
	PARTS LIST AND SCHEMATICS	40
	APPENDIX	48

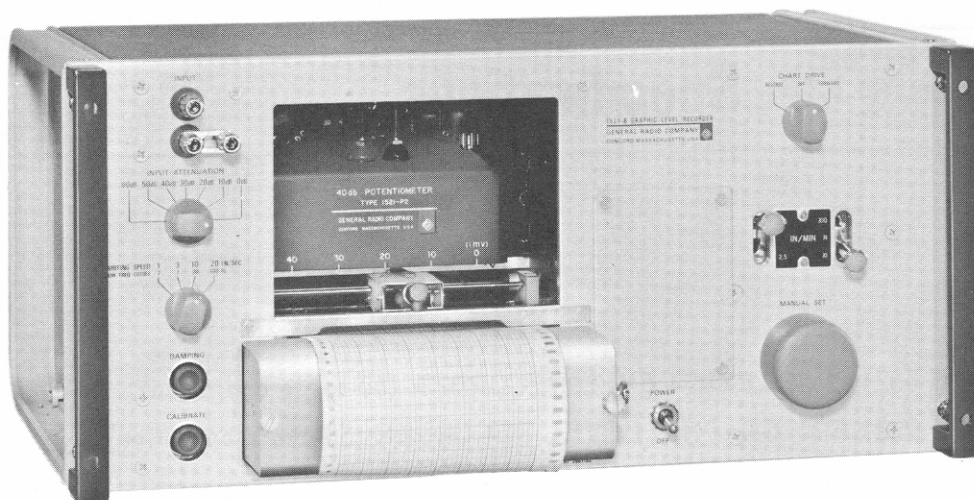

Figure 1.1. Type 1521-B Graphic Level Recorder.

Condensed Operating Instructions

GENERAL OPERATION (AC). The following steps can be used as a general guide for preparing the Type 1521 Graphic Level Recorder for operation. Refer to Section 3 for detailed instructions that include calibrating the 0-dB level to 1mV, level-vs-time recording, level-vs-frequency recording, and operation with other GR instruments and accessories.

- a. Pivot the marker (pen) to the up (non-writing) position.
- b. Set the WRITING SPEED control to 1 or 3 in/sec.
- c. Apply the incoming signal (maximum 100 V, rms) to the INPUT terminals.
- d. Position the pen on the chart paper by selecting the desired attenuation applied to the input signal.

For absolute-level (millivolts) operation, the INPUT ATTENUATION setting is added to the dB reading on the chart paper to give level of input above 1mV when the 0-dB reference is calibrated to 1mV.

For relative-level (in dB with respect to an arbitrary reference) operation, set the INPUT ATTENUATOR and CALIBRATE controls to position the marker at the desired 0-dB reference level. (If the CALIBRATE control is adjusted, 0dB on the chart paper no longer represents 1mV.)

- e. Set the WRITING SPEED control to the fast-

est acceptable writing speed. (This control determines maximum pen velocity and servo bandwidth).

- f. Set overshoot by means of the DAMPING control: turn cw to increase damping, ccw to decrease.

- g. Set gear-shift levers for desired chart-paper speed. Turn CHART DRIVE switch to FORWARD. To stop chart drive, shift right-hand lever to N (neutral); do not shift left-hand lever to change speeds while chart is moving.

- h. With chart paper in motion, pivot marker to its down (writing) position to start recording.

DC OPERATION. With the Type 1521-P4 Linear Potentiometer installed in the recorder, waveforms of low-frequency signals can be recorded by adjusting the DAMPING control as follows:

- a. Using the zero thumb control on the front of the dc potentiometer, set the zero input position of the marker about five divisions from the left side of the chart.

- b. Set the WRITING SPEED control to 20 in./sec and the INPUT ATTENUATOR switch to 0.

- c. Apply about 0.5 V dc to the INPUT connectors (e.g., a 1.5-V dry cell with 2 k Ω in series).

- d. Turn the chart drive on.

- e. Switch the INPUT ATTENUATOR back and forth, from 0 to 10 dB.

- f. Adjust the DAMPING control so that the overshoot is two divisions on the Type 1521-9428 Paper.

Specifications

TYPE 1521-B GRAPHIC LEVEL RECORDER (60-cycle operation)

TYPE 1521-BQ1 GRAPHIC LEVEL RECORDER (50-cycle operation)

Recording Range: As supplied, 40 dB full-scale; 20-dB and 80-dB ranges are also available. For dc recording, 0.8 to 1 V (0.8 to 1.0 mA) full-scale, with zero position adjustable over full scale.

Frequency Response and Writing Speed

Level Recording: High-frequency response ± 2 dB to 200 kHz. Low-frequency sine-wave response depends on writing speed, as shown in following table:

Writing Speed (approx) in./s with 0.1-inch overshoot	Low-Frequency Cutoff Hz (less than 1 dB down)
20	100
10	20
3	7 (3 dB down at 4.5 Hz)
1	7 (3 dB down at 4.5 Hz)

Dc Recording: 3 dB down at 8 Hz (pk-pk amplitude less than 25% of full scale).

Potentiometer Linearity

20-, 40-, 80-dB Potentiometers: $\pm 1\%$ of full-scale dB value plus a frequency error of 0.5 dB at 100 kHz and 1.5 dB at 200 kHz.

Linear Potentiometer: $\pm 1\%$ of full scale.

Resolution $\pm 0.25\%$ of full scale.

Max Input Voltage: 100 V ac.

Input Attenuator: 60 dB in 10-dB steps.

Input Impedance: 10,000 Ω for ac level recording; 1000 Ω for dc recording.

Max Sensitivity: 1 mV at 0 dB for level recording; 0.8 or 1 V full-scale for dc recording.

Paper Speeds

High-speed motor (normally supplied): Paper speeds of 2.5, 7.5, 25, 75 in./min. Used for high-speed-transient measurements and with Type 1304 Beat-Frequency Audio Generator.

Medium-speed motor (supplied on request): Paper speeds of 0.5, 1.5, 5, 15 in./min. Used with analyzers and in level-vs-time plots.

Low-speed motor (supplied on request): Paper speeds of 2.5, 7.5, 25, 75 in./h. Used for level-vs-time measurements from 1 to 24 h.

External Dc Reference: An external dc reference voltage of from 0.5 to 1.5 V can be applied internally to correct for variations of up to 3 to 1 in the signal source of the system under test.

Detector Response: Rms within 0.25 dB for multiple sine waves, square waves, or noise. Detector operating level is 1 V.

Chart Paper: 4-inch recording width on 5-inch paper. All rolls are 100 feet long. See full list of charts, Table 1-2.

Accessories Supplied: 40-dB potentiometer, 12 disposable pens with assorted ink colors, 1 roll of 1521-9428 chart paper, power cord, spare fuses, 1560-P95 Adaptor Cable (phone to double plug).

Accessories Available: Potentiometers, chart paper, pens, high-, medium-, and low-speed motors, drive and link units.

Power Required: 105 to 125 or 210 to 250 V, 50 or 60 Hz, 35 W.

Mounting: Rack-Bench Cabinet.

Dimensions (width x height x depth): Bench model, 19 x 9 x 13½ in. (485 x 230 x 345 mm); rack model, 19 x 8¾ x 11¼ in. (485 x 225 x 290 mm).

Weight: Net, 50 lb (23 kg); shipping, 62 lb (29 kg).

Catalog Number	Description
Graphic Level Recorder	
1521-9812	1521-B, Rack Model (for 60-Hz supply)
1521-9802	1521-B, Bench Model (for 60-Hz supply)
1521-9507	1521-BQ1, Rack Model (for 50-Hz supply)
1521-9506	1521-BQ1, Bench Model (for 50-Hz supply)

U. S. Patent No. 2,581,133

Licensed under patents by AT & T Co.

General Radio Experimenter Reference:

Vol 38, No. 9, September 1964.

NOTE: The abbreviation for cycles per second in this manual or on the instrument may be cps, c/s, or Hz.

SECTION 1

INTRODUCTION

1.1 PURPOSE. The Type 1521-B Graphic Level Recorder (Figure 1.1) produces a permanent ink record of the level of ac voltages, at frequencies from 7 cps to 200 kc. The trace, which is proportional to the logarithm of changes in input level, and hence linear in decibels, may be plotted as a function of time, on translucent chart paper. When the recorder is set up to drive the dial of an external oscillator, it automatically plots level vs frequency, yielding a permanent record with minimum time and effort. The translucent paper permits superposition of one recording over another for comparison. Recording width is four inches.

Fast writing speed in conjunction with a wide servo bandwidth enables the Type 1521-B to record rapidly changing signal levels from the outputs of various electrical and electroacoustic devices. Writing speed is high enough for most reverberation-time measurements.

The Type 1521-B can also be used as a dc recorder, with an input-voltage range of 0 to 0.8 volt.

1.2 GENERAL DESCRIPTION. (See Figure 1.2.) The Type 1521-B is a servo-type recorder. The input signal is fed through an input step attenuator to a potentiometer which is automatically positioned to maintain a constant 1-mv ac signal at the wiper arm output. This output voltage is amplified and then rectified by a quasi-rms detector (refer to paragraph 4.3). The detector's dc output voltage is compared with a 1-volt reference, and the difference (error) voltage is amplified by a dc amplifier. The push-pull output current from the dc am-

plifier passes through the drive coil, which is suspended in a magnetic field. The interaction between the coil current and the magnetic field moves the wiper arm to reduce the error voltage to zero (null condition), and also positions the pen mounted on the coil assembly. Since potentiometer output is a constant 1 mv at null, the attenuation of the input potentiometer is directly proportional to the level of the input signal. By suitable shaping of the potentiometer, a scale linear in db is achieved.

A feedback voltage, proportional to velocity, is subtracted from the error signal at the input to the dc amplifier. This voltage provides damping so that the drive coil will not oscillate, and varies the servo bandwidth and maximum writing speed.

The moving drive coil, then, responds to changes in the input level of a voltage applied to the recorder, and a pen fastened to the coil will trace out these changes on paper. For instance, if the input level increases by 10 db, the drive coil (along with the pen) moves the potentiometer wiper arm to restore the voltage

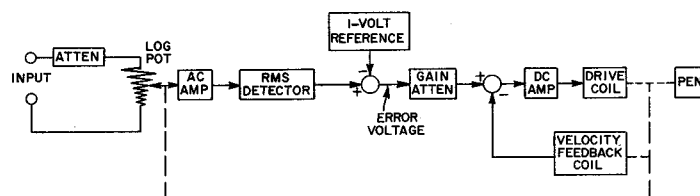

Figure 1.2. Block diagram of recorder.



in the arm to about 1 mv. Since the potentiometer is logarithmic, the wiper arm moves downscale 10 db, indicating a level change of 10 db directly on the chart paper.

The Type 1521-B responds to the rms level of the ac waveform, and is less influenced by the waveshape of the input signal than it would be with a peak- or average-response detector. The rms response is particularly useful in noise measurements, where peak response would cause large errors in measurement.

When used as a level recorder, the Type 1521-B has an input impedance of 10,000 ohms. This impedance can be increased, at a sacrifice of sensitivity, by the addition of a series resistor at the input.

When the recorder is used as a dc recorder, the ac amplifier is bypassed and a linear potentiometer is used. The input impedance of the dc recorder is 1000 ohms.

1.3 WRITING SPEED. The maximum writing speed (saturated pen velocity) is 20 in./sec for 0.1 inch overshoot. The corresponding servo bandwidth for small-amplitude variations is from dc to 10 cps. This bandwidth determines the ability of the recorder to follow

changes in input level, and is **not** related to the frequency of the ac input signals. With a fast writing speed, the pen should follow any level variations normally encountered in level recording. Such fast speed can, however, present too much information, as, for instance, in a loudspeaker frequency-response curve recorded in a small reverberant room. Filtering can be added to smooth the rapid level fluctuations to obtain an averaged response of the loudspeaker. This filtering is accomplished by reduction of the servo bandwidth and maximum writing speed.

1.4 PAPER SPEED. The paper is driven by a synchronous motor, at speeds of 2.5, 7.5, 25, or 75 in./min. (Two alternate motors are available: a slow-speed motor for speeds from 2.5 to 75 in./hr and a medium-speed motor for speeds from 0.5 to 15 in./min.) The direction of paper drive can be reversed.

1.5 ACCESSORIES. Table 1.1 lists the accessories supplied with the recorder and Table 1.2 lists those available from General Radio.

Table 1.1
ACCESSORIES SUPPLIED

Reference	Description	Quantity	Part Number
Fig. 1.3	1 Marker-Set Combination (12 markers per set). Each set includes 4 each of red, green, and blue markers	1 set	1521-9449
	2 Power Cable, 7-foot, 3-wire	1	4200-9622
	3 Potentiometer, 40 dB, Type 1521-P2	1	1521-9602
	4 Paper, recording	1 roll	1521-9428
	5 Fuse 0.5 A for 115-V operation, or 0.25 A for 230-V operation	2*	5330-1000
	6 Adaptor Cable, Type 1560-P95	2*	5330-0700
Fig. 1.1	End-Frame Set, for bench mounting	1 set	5310-9650
	Rack Support Set, for rack installation	1 set	7863-9650

* Fuses for 115-V operation are normally supplied; fuses for 230-V operation are supplied only when specified.

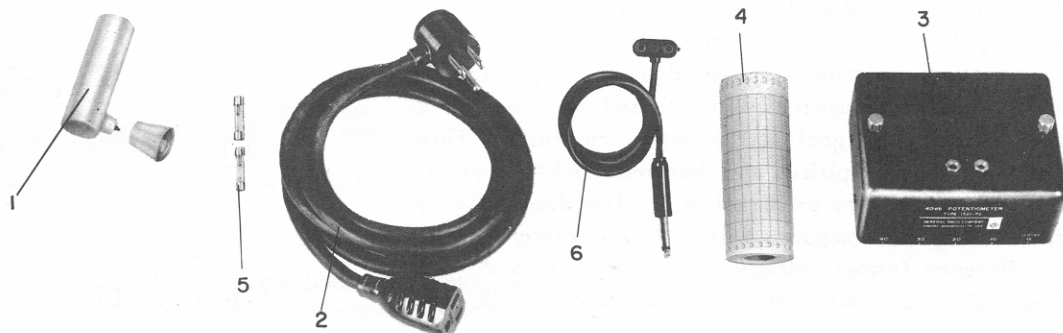

Figure 1-3. Accessories supplied. (For legend, see Table 1.1)

TABLE 1.2
ACCESSORIES AVAILABLE

DRIVE AND LINK UNITS FOR COUPLING TO GENERATOR AND ANALYZERS

Catalog
Number

1521-P10B Drive Unit

Provides mechanical-drive output from 1521-B to operate any link unit.

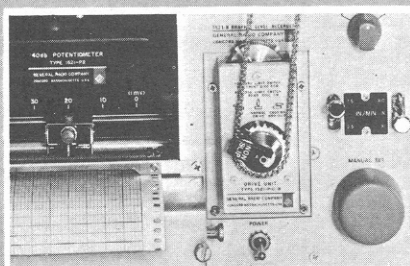

1521-9467

1521-P15 Link Unit

For mechanical coupling to 1304-B oscillator or to 1564 or 1568 analyzers. Fitted with 24-tooth sprocket. Includes chain.

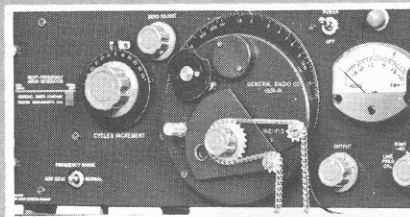

1521-9615

1521-P16 Sprocket Kit, contains 5 sizes of interchangeable sprockets for 1521-P15: 40, 36, 32, 20, and 16 teeth. Provides choice of scale factor in proportion to that with normal 24-tooth sprocket. Includes chain.

INDUSTRY SCALE FACTORS

Industry Standard	Scale Factor (dB/decade)	Decade Length (inches) for Type 1304 Generator	Sprocket (teeth)	Pot (dB)
Institute of High Fidelity Manufacturers	20	2.0	16	40
Proposed International Standard	25	2.5	20	40
Electronic Industries Association	30	3.0*	24	40
Institute of High Fidelity Manufacturers	20	4.0	32	20
Hearing Aid Industry	45	4.5	36	40
Proposed International Standard	50	5.0	40	40
Proposed International Standard	50	5.0**	16	40

* Chart paper available for Type 1304-B Beat-Frequency Audio Generator.
** Decade length applies to Type 1564-A Sound and Vibration Analyzer; chart paper available.

1521-9616

1900-P1 Link Unit

For coupling to 1900-A Wave Analyzer. Use with chart paper 1521-9464 for scale of 10 kHz per 20 in. and with 1521-9465 for scale of 50 kHz per 10 in. Chain included.

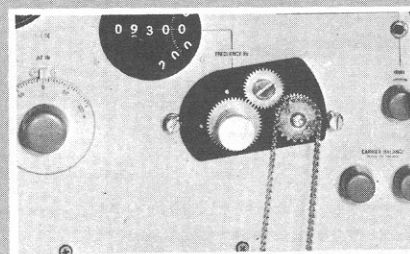

1900-9601

1900-P3 Link Unit

For coupling to 1900-A Wave Analyzer. Use with chart paper 1521-9464 for scale factors of 10 kHz per 20 in. or expanded 1 kHz per 20 in.

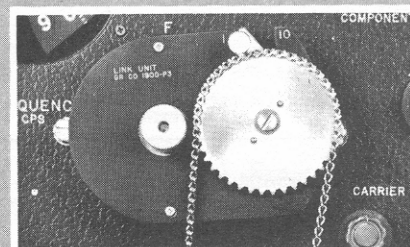

1900-9603



TABLE 1.2 (cont)

					Catalog Number	Price in USA	
1564-P1 Dial Drive Electromechanical coupler between 1521-B recorder and 1564-A Sound and Vibration Analyzer. Generates chart records of "stepped" one-third octave analysis. Keeps synchronism between continuous chart-paper feed and stepped analyzer motion, i.e., where 1564 dwells for selected interval at each third-octave center frequency. Also provides for continuous swept-frequency analysis. Uses chart paper 1521-9460 for stepped mode, 1521-9469 for continuous analysis.					Bench Model Rack Model	1564-9771 1564-9772	
CHART PAPERS †							
Associated Instrument	Calibration		Chart Length (in.)				
	Horizontal	Vertical (Div)	Cal.	Blank			
1304-B Generator with 1521-P15 Link Unit	20 Hz-20 kHz, log	80	9	4½	1521-9427	\$2.75	
1900-A Analyzer with 1900-P1 or 1900-P3 Link Units	0-1 or 0-10 kHz, linear	40	20	0	1521-9464	2.75	
1900-A Analyzer with 1900-P1 Link Unit	0-50 kHz, linear	40	16	0	1521-9465	2.75	
1564-A Analyzer with 1521-P15 Link Unit and 24-tooth sprocket	2.5-25 normalized, log	40	7½	1½	1521-9493	2.75	
1564-A Analyzer with 1521-P15 Link Unit and 16-tooth sprocket or with 1564-P1 Dial Drive (continuous mode)	2.5-25 normalized, log	40	5	1	1521-9469	2.75	
1564-A Analyzer with 1564-P1 Dial Drive (stepped mode)	Third-octave bands 3.15 Hz-25 kHz	40	10	0	1521-9460	2.75	
1568-A Analyzer with 1521-P15 Link Unit	2-20 normalized, log	40	10	2	1521-9475	2.75	
1554-A Analyzer	2.5 Hz-25 kHz, log	40	18	3	1521-9463	2.75	
760-B Analyzer	25-7500 Hz, log	40	12½	1	1521-9429	2.75	
General use	Continuous ¼-in. div	40	Continuous		1521-9428	2.75	
1136-A D/A Converter	Continuous ⅝-in. div	50	Continuous		1521-9466	3.25	
POTENTIOMETERS							
					1521-P1 20-dB Potentiometer 1521-P2 40-dB Potentiometer* 1521-P3 80-dB Potentiometer 1521-P4 Linear Potentiometer (for dc)	1521-9601 1521-9602 1521-9603 1521-9604	
*Normally supplied with the recorder							
OPTIONAL MOTORS **							
					Chart Speeds		
High-Speed Motors	Used for high-speed-transient measurements and with 1304 Beat-Frequency Audio Generator. Not for use with 1900-A, 1564-A, and 1568 analyzers, 1564-A, and 1568 analyzers.	1521-P19 (for 60-Hz supply) normally supplied in recorder**) 1521-P21B (for 50-Hz supply)		2.5-75 in./min 2.5-75 in./min	1521-9619 1521-9921		
Medium-Speed Motors	Used with analyzers and in level-vs-time plots.	1521-P23 (for 60-Hz supply) 1521-P24 (for 50-Hz supply)		0.5-15 in./min 0.5-15 in./min	1521-9623 1521-9624		
Low-Speed Motors	Used for level-vs-time measurements 1-24 hours.	1521-P20B (for 60-Hz supply) 1521-P22 (for 50-Hz supply)		2.5-75 in./h 2.5-75 in./h	1521-9513 1521-9622		
** Recorder can be supplied with low- or medium-speed motor installed, at same price as with standard motor.							
fastrak PEN SETS AND CONVERSION KIT							
The pen used in the 1521-B recorder combines ink reservoir and writing point in a single disposable unit, eliminates refilling. Each cartridge has about twice the life of one old-style pen refill and can outlast three rolls of chart paper. The pen consists of a sealed plastic cartridge with a fiber plastic point that requires only about 2 grams of force to operate properly. The pens are available with red, green, and blue ink and are supplied in sets of twelve pens. A set of assorted colors is included with the recorder and with the conversion kit. For converting older 1521-A and 1521-B recorders to use the improved pen, a kit is available that contains a pen holder, set of 12 assorted-color pens, and conversion instructions.							
					fastrak Marker Set, Red fastrak Marker Set, Green fastrak Marker Set, Blue fastrak Marker Set, Assorted Colors fastrak Recorder Marker Conversion Kit	1521-9446 1521-9447 1521-9448 1521-9449 1521-9439	15.00 15.00 15.00 15.00 25.00

†NEW Chart Papers:

Associated Instrument	Calibration		Chart Length		Catalog Number	Price In USA
	Horizontal	Vertical (Div)	Cal.	Blank		
1564-A Analyzer	1/3-octave bands, 2.5 Hz - 20 kHz	80	12	0	1521-9471	\$2.75
1304-B Generator	20 Hz - 20 kHz, log	40	7½	3¾	1521-9473	2.75

SECTION 2

INSTALLATION

2.1 GENERAL. The Type 1521 recorder should be installed so it is reasonably level during operation. The use of transistors in the recorder makes ventilation less of a consideration than it would be with vacuum tubes, but operation at high temperatures (above 45 °C) is not recommended.

The recorder is available with end-frames for bench mounting or with rack-mounting hardware for installation in a EIA standard (RS-310) 19-in. relay rack with universal mounting - hole spacing. Appropriate mounting accessories are available if it becomes necessary to convert from one mounting style to another. With available hardware, the recorder equipped with end frames can be stacked with one or more bench-mount instruments (refer to paragraph 2.4).

Refer to the parts list for a detailed listing of these mounting accessories.

2.1.1 MOUNTING.

BENCH. To install a set of end frames, proceed as follows:

a. With the instrument resting on its right-hand side, place the left-hand end frame on the left side of the instrument with the feet (A) toward the bottom of the recorder (see Figure).

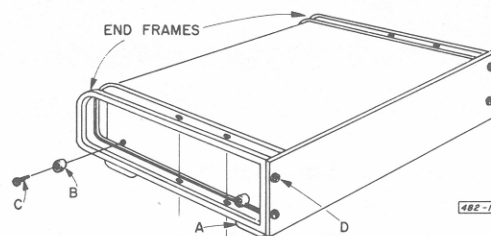

End frame mounting diagram.

b. Insert four No. 10-32, 3/8-inch screws (C) into the aluminum clamps (B).

c. Mount the end frame by installing the screw and clamp assemblies in the four holes in the side of the cabinet. Be sure that the cutout portion of the clamp (B) goes over the ridge of the end frame and that the remaining part of the clamp is against the cabinet. Push the front end of the end frame against the back of the instrument panel before tightening the clamp screws.

d. Thread two panel screws (D) through the panel and into the end frame.

e. Repeat the above steps to install the right-hand end frame.

To remove the instrument from the cabinet, it is not necessary to remove the end frames. Remove the panel screws (D) and two cabinet-to-chassis screws at the back of the cabinet. Slide the instrument forward and out of the cabinet.

RACK. Instructions for installing the recorder in a relay rack are provided with the available rack support set.

2.1.2 PAPER LOADING. (Refer to Figure 2.1). To load the recorder with paper, proceed as follows:

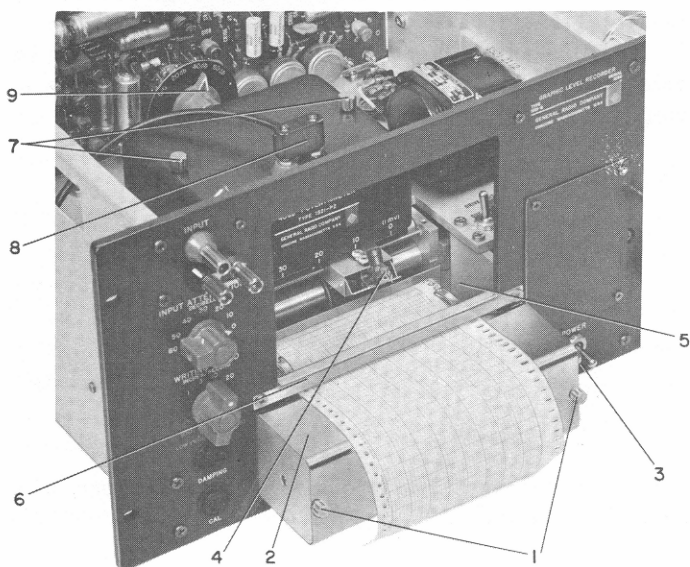

Figure 2.1. Front oblique view of recorder.

- | | |
|----------------|----------------------------------|
| 1. Thumbscrews | 6. Tear gate |
| 2. Paper cover | 7. Thumbscrews |
| 3. Paper knob | 8. Potentiometer input plug |
| 4. Pen | 9. Potentiometer selector switch |
| 5. Fingers | |

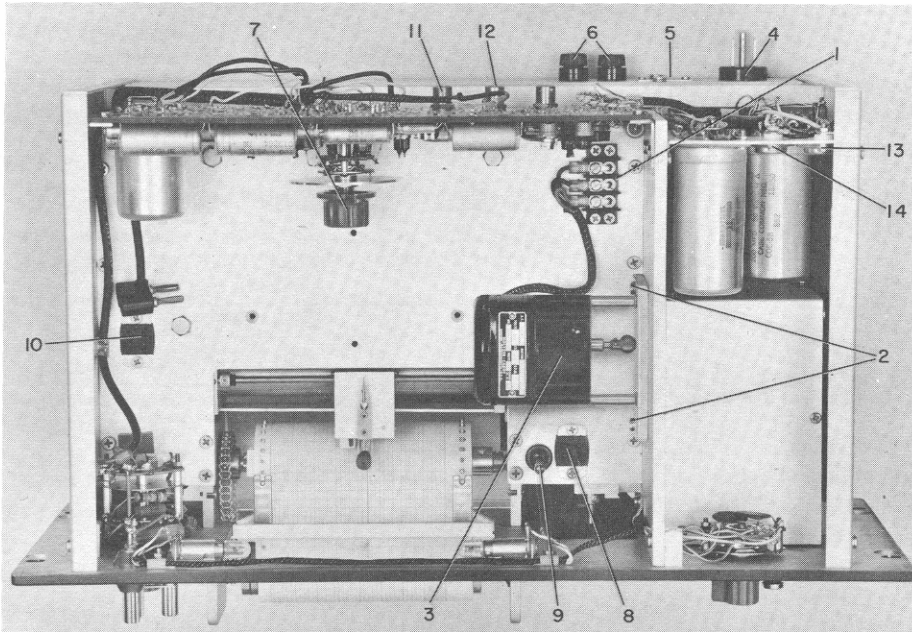

Figure 2.2. Top view of recorder

1. Motor terminal strip
2. Motor-mounting screws
3. Motor
4. Power connector
5. Power nameplate
6. Fuses
7. Potentiometer selector switch
8. Drive-unit connector
9. External-motor switch
10. Dc potentiometer connector
11. OVERSHOOT adjustment
12. CREEP adjustment
13. Transistor Q_1
14. Transistor Q_2

a. Remove the two thumb screws (1, Figure 2.1), and remove the paper cover (2).

b. Pull out the spring-loaded paper knob (3), and insert the roll of paper, with the loose end at the bottom, facing in toward the recorder. Press the right-hand paper hub to force the paper roll against the shoulder of the left-hand paper hub.

c. Grasp the pen (4) and swing it up, away from the drum.

d. Guide the paper under and around the drum, using the left hand.

e. Set the gear-shift lever to N and turn the MANUAL SET knob clockwise with the right hand. Let the pins pull the paper only as far as the pen.

f. Attach the paper cover (2) and fasten it with the two thumbscrews.

g. Move the paper along by turning the MANUAL SET knob, guiding the edge under the pen (4) and fingers

(5). The paper should go over the top of the paper cover and under the tear gate (6). It may be necessary to push down slightly on the paper cover.

h. To tear the paper, lift it from one edge against the tear gate. The paper cover provides a convenient writing surface.

2.1.3 MARKER INSTALLATION AND USE. The marker operates on the same principle as the nylon-tip writing pen. Unlike the pen, excessive force or writing pressure will permanently widen the tip, resulting in excessive line width. The correct writing force required to prevent marker-tip damage, prevent skipping, and ensure satisfactory line width (0.008 to 0.025 in.) is 1.5 to 2 grams.

To install the marker: remove the protective cap, insert the marker in the holder (give it a slight twist as it enters), and lock it in the groove at the front of the holder.

To record: lower the marker until the tip is close (about 1/16 in.) to the chart paper, then let it drop.

TABLE 2.1

POTENTIOMETER INPUT-LEVEL RANGES

Input-voltage range recorded on 4-inch paper.

Attenuator Setting db	80-db Pot.	40-db Pot.	20-db Pot.
0	1 mv - 10 v	1 - 100 mv	1 - 10 mv
10	3 mv - 30 v	3 - 300 mv	3 - 30 mv
20	10 mv - 100 v	10 mv - 1 v	10 - 100 mv
30	30 mv - 100 v*	30 mv - 3 v	30 - 300 mv
40	100 mv - 100 v*	100 mv - 10 v	100 mv - 1 v
50	300 mv - 100 v*	300 mv - 30 v	300 mv - 3 v
60	1 - 100 v*	1 - 100 v	1 - 10 v

*Limited by attenuator power rating.

CAUTION

Do not strike the marker-tip against any object. Do not snap the marker down from its normal (nonwriting) position. Do not press the marker down on the chart paper. LET THE MARKER DROP FROM A POINT JUST ABOVE THE CHART PAPER.

Refer to the complete instructions provided with each set of markers.

2.1.4 **INSTALLING THE POTENTIOMETER.** A 40-db potentiometer is supplied installed in the recorder. Two other logarithmic potentiometers and a linear potentiometer are also available. Select a logarithmic potentiometer on the basis of the dynamic range of input levels to be recorded (refer to Table 2.1), and select the linear unit for dc recording.

All potentiometers can be installed without removal of the instrument from its case. When changing potentiometers, remove the unit to be replaced as follows: Remove the input plug (8, Figure 2.1) and loosen the captive thumbscrews (7) enough to free the potentiometer. Then remove the potentiometer by withdrawing it through the opening in the front panel. On linear potentiometers, a multipoint connector on the left-hand side must be unplugged before the potentiometer can be removed.

To install a potentiometer, proceed as follows:

a. Set the potentiometer selector switch (9) to the position corresponding to the potentiometer being installed. The pins at the rear of the potentiometer case are guide pins that clear the selector switch only if it is set properly.

b. Move the input plug and cable out of the way, and insert the potentiometer through the panel opening. Two locating pins on the bottom of the potentiometer and mating holes in the shelf assure proper seating of the unit. When the potentiometer is in place (see Figure 2.1), tighten the thumbscrews (7) and connect the input plug (8). With a linear potentiometer, connect the multipoint plug in the mating socket (10, Figure 2.2).

2.1.5 **MOTOR INSTALLATION.** A standard-speed (300-rpm) motor is supplied installed in the recorder. A slow-speed (5-rpm) motor and a medium-speed (60-rpm) motor are also available. To change motors, proceed as follows:

a. Remove the potentiometer, as described in paragraph 2.1.4.

b. Remove the four black thumbscrews at the front panel and the two at the rear of the instrument, and slide the recorder out of its case.

c. Loosen the three screws holding the motor leads to the terminal strip (1, Figure 2.2), and slip the lugs out.

d. Remove the two motor-mounting screws and lock washers (2).

e. Remove the motor (3).

f. Install the new motor, positioning the mounting plate so that the bearing and screws mate with the proper holes. Fasten the motor; use the screws and lock washers removed in step d.

g. Fasten the three motor leads to the terminal strip in accordance with the color coding (R, B, G, for red,

black, gray respectively) stamped on the shelf.

h. Replace the potentiometer as described in paragraph 2.1.4, slide the instrument back into its case, and replace the six screws removed in step b.

2.1.6 **POWER CORD.** Connect the power cord to the three-prong connector at the rear of the recorder (4, Figure 2.2). A small nameplate (5) to the right of this connector indicates the voltage and frequency for which the recorder is wired. A good ground connection should be made to the third conductor of the power cable to prevent 60-cycle pickup.

The recorder, normally supplied for 115-volt operation, can be rewired for 230-volt use, as shown on the schematic diagram. The Type 1521-B is wired to operate from a 60-cycle line and the Type 1521-BQ1 will operate from a 50-cycle line.

2.1.7 **CONNECTIONS TO AUXILIARY EQUIPMENT.** A three-terminal INPUT connection is provided for the measurement of ac voltages with dc potentials above ground. High dc potentials should not be applied to the red and black input terminals, in view of the 1-watt power rating of resistors in the attenuator.

For the normal measurement, where the low side of the input is at ground potential, connect the grounding link between the ground and black binding posts, and use the red and black posts as input connectors. If both input terminals have a dc potential above ground, remove the grounding link from the black binding post, and use the red and black posts as input connectors. Connect the chassis or ground of the circuit under test to the ground binding post. The ac impedance between the black binding post and chassis ground must be low to prevent hum pickup. To check this, make all connections except that to the red terminal, short-circuit the red and black binding posts, turn the recorder on, and check that the pen moves off scale at the 0-db end of the potentiometer. It may be necessary to connect a capacitor between the black and ground binding posts to provide an impedance low enough for the pen to move off scale. If hum pickup

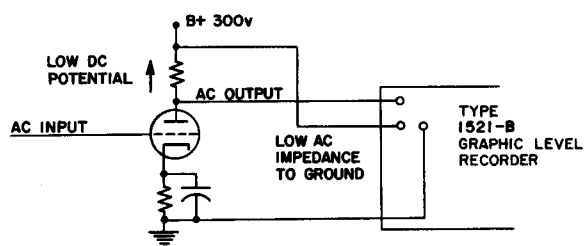

Figure 2.3. Connections for three-terminal ac measurements.

is still such that a pronounced beat occurs with a 61-cycle input, more capacitance should be added to lower the impedance.

The connections for a typical three-terminal ac measurement are shown in Figure 2.3.

The three-terminal INPUT is also useful for dc measurements, where both measurement points are above ground.

2.2 LEVEL-VS-FREQUENCY RECORDING.

2.2.1 GENERAL. The instrument is supplied set up for time-base measurements, using Type 1521-9428 linear chart paper. Several accessories are required to convert the instrument to a frequency-base level recorder.

2.2.2 DRIVE-UNIT INSTALLATION. The Type 1521-P10B Drive Unit consists of (1) gears and sprocket to couple the recorder to the external instrument, (2) a clutch to permit decoupling between the recorder drive and the sprocket, and (3) Microswitches to turn the motor off at each end of the sweep. The Drive Unit may be installed permanently on the recorder, since the clutch can be used to disconnect the Drive Unit when the latter is not in use.

To install the Drive Unit, proceed as follows:

- a. Remove the cover plate to the right of the front-panel opening by removing the four phillips-head screws.
- b. Connect the Drive-Unit plug to the socket between the motor and the front panel of the recorder (8, Figure

2.2). Snap the switch (9) next to this socket toward the front of the recorder, to connect the Microswitches into the motor circuit.

c. Install the Drive Unit, using the screws removed in step a. Adjust the height of the Drive Unit so that the gears mesh with a slight amount of backlash.

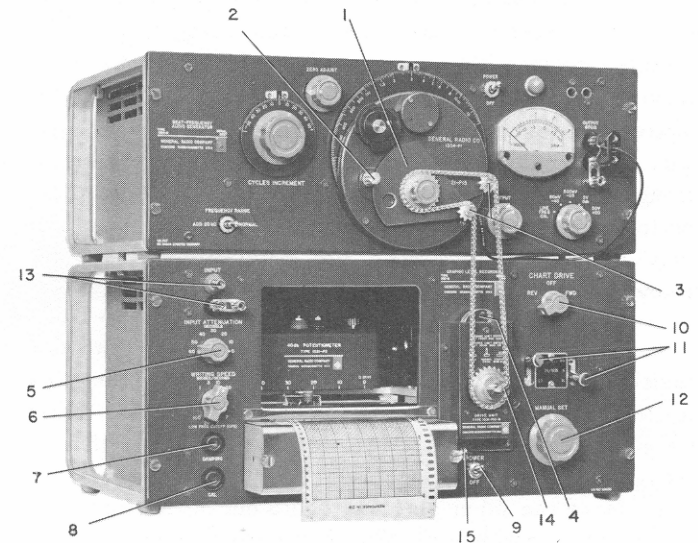

Figure 2.4. Recorder attached to Type 1304-B Beat-Frequency Audio Generator to form the Type 1350-A Generator-Recorder Assembly.

- | | |
|------------------------------|---------------------------|
| 1. Link unit | 8. CALibration adjustment |
| 2. Cam-holding screw | 9. POWER switch |
| 3. Idler sprockets | 10. CHART DRIVE switch |
| 4. Microswitch stops | 11. Chart-speed controls |
| 5. INPUT ATTENUATION control | 12. MANUAL SET control |
| 6. WRITING SPEED control | 13. INPUT terminals |
| 7. DAMPING adjustment | 14. Drive-unit clutch |
| | 15. Paper knob |

2.2.3 INSTALLATION OF LINK UNIT ON TYPE 1304-B BEAT-FREQUENCY AUDIO GENERATOR OR TYPE 1564-A SOUND AND VIBRATION ANALYZER. A Link Unit, including sprocket and chain, must be installed on the frequency dial of the driven instrument to couple it properly to the recorder. The Type 1521-P15 Link Unit (Figure 2.4) is designed to couple the recorder to the Type 1304-B Beat - Frequency Audio Generator (for the Type 1350-AR Generator-Recorder Assembly). The Link Unit also couples the recorder to the Type 1564-A Sound and Vibration Analyzer in the Type 1911-A Recording Sound and Vibration Analyzer (Figure 2.5).

To install the Type 1521-P15 Link Unit, proceed as follows:

- a. Place the Type 1304-B either above or below the recorder in a relay rack or on a bench (see Figure 2.4). The Type 1564-A should always be placed above

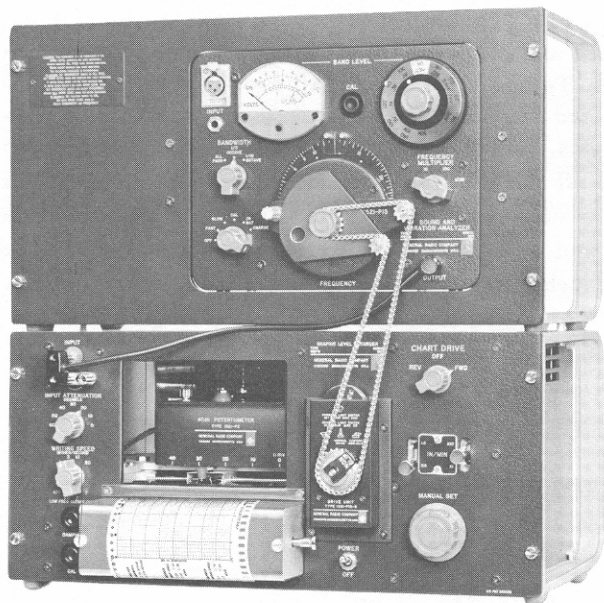

Figure 2.5. Type 1911-A Recording Sound and Vibration Analyzer consisting of the recorder attached to Type 1564-A Sound and Vibration Analyzer.

the recorder (see Figure 2.5).

b. Remove the two screws attaching the knob-and-plate assembly to the panel of the driven instrument, and remove the knob and plate.

c. Using the screws removed in step b (but not the lockwashers), mount the Link Unit in place of the knob. Adjust the position of the Link Unit so that there is a slight amount of backlash when the sprocket is turned.

d. Slip the chain over the sprockets of the Drive and Link Units. (See Figures 2.4 and 2.5.)

e. Tighten up any slack in the chain by first loosening the screw (2, Figure 2.4) and then swinging the idler sprocket (3) to take up the slack in the chain. Tighten the screw (2).

NOTE

On the Type 1564 Sound and Vibration Analyzer, the 1900-A Wave Analyzer and on recent models of the Type 1304-B Beat-Frequency Audio Generator, the frequency dial can be rotated through 360°. With these instruments, it is desirable to remove the Drive-Unit Microswitches so that the frequency dial can sweep through the entire 360°. To cut out the Microswitches, snap the toggle switch (9, Figure 2.2) toward the rear of the instrument.

2.2.4 CHANGING SPROCKETS ON TYPE 1521-P15 LINK UNIT. A Type 1521-P16 Sprocket Kit is available for use with the Type 1521-P15 Link Unit. By changing sprockets, it is possible to change the length of the recording paper covered by a given angle of dial rotation (refer to paragraph 3.4.5). To change the sprockets:

1. Loosen the setscrews and remove the knob.
2. Remove the sprocket.
3. Slide the new sprocket onto the shaft with the hub facing away from the panel.
4. Replace the knob.

Be sure the pin on the shaft engages the key slot on the sprocket before the setscrews are tightened.

2.2.5 INSTALLATION OF THE LINK UNIT ON THE TYPE 760-B SOUND ANALYZER. The Type 1521-P12 Link Unit is designed to couple the Type 760-B Sound Analyzer (now obsolete) to the recorder. To install this unit, proceed as follows:

a. Set the frequency dial to an integral setting and note the frequency.

b. Remove one of the two screws holding the frequency pointer on the Type 760-B, and swing the pointer out of the way of the dial.

c. Loosen the two setscrews holding the frequency knob to its shaft, and remove the knob-and-dial assembly.

Be careful not to move the shaft. If the shaft does turn, the analyzer can be recalibrated with a 60-cycle line source.

d. Install the Type 1521-P12 LinkUnit on the shaft, and replace the pointer.

e. Set the dial frequency to that noted in step a, and tighten the setscrews.

f. Four rubber feet are supplied with the Link Unit to act as spacers between the analyzer and the recorder. Install these permanently on the bottom of the analyzer by means of the four wood screws supplied.

g. Place the analyzer above the recorder and attach the chain to the drive and link sprockets. Move the analyzer to take up the chain slack.

h. Disconnect the Microswitches on the recorder, as described in NOTE, paragraph 2.2.3, step e.

2.3 DC RECORDING. To prepare the recorder for dc measurements, proceed as follows:

a. Install the dc linear potentiometer (refer to paragraph 2.1.4).

b. Set the INPUT ATTENUATOR switch to 0 db for maximum sensitivity. Refer to paragraph 3.5 for adjustment of the DAMPING control.

2.4 STACKING. When two or more bench instruments are to be stacked (see Figures 2.4 and 2.5), use the available hardware set (refer to parts list) and proceed as follows:

a. Place the instrument on top of the base instrument with the feet of the end frame in the channel of the base end frames (see Figure).

b. Place a 15/32-inch spacer (A) over each of the four holes on the top of the base end frames and line up the holes in the bottom of the end frames on the top instrument with the spacers.

c. Insert a No. 10, 1-inch screw (B) through each of the four holes in the bottom of the end frame on the top instrument and see that the screw comes through the top of the bottom end frame.

d. Tighten the assembly by securing a No. 10 locking nut (C) on each of the four mounting screws.

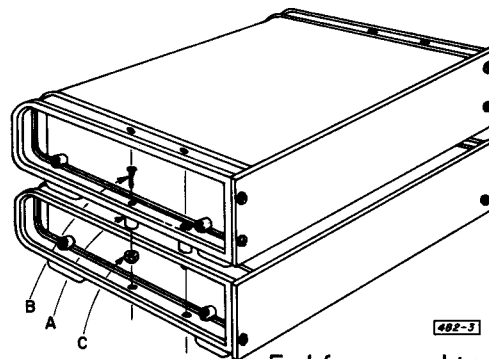

End frame stacking diagram



SECTION 3

OPERATING PROCEDURE

3.1 CONTROLS. Tables 3.1, 3.2, and 3.3 list the functions of all controls on the recorder. Study this list to gain an over-all familiarity with the instrument before attempting to operate it.

3.2 GENERAL OPERATION.

3.2.1 PLACING THE RECORDER IN OPERATION. (Refer first to Section 2 for installation instructions.) Lift the pen off the paper and set the WRITING SPEED control to a slow position (1 or 3 in./sec). This will protect the coil assembly from banging on the stops when the instrument is turned on. Now the POWER switch may be turned ON.

3.2.2 APPLYING THE SIGNAL TO THE INPUT. Apply the signal to be recorded to the INPUT terminals; use a shielded cable. (Refer to paragraph 2.1.7.) A dc blocking capacitor should be used when recording ac voltages with superimposed dc. A 15 μ F electrolytic

capacitor, polarized in the proper direction, will ensure accurate recording down to 5 c/s.

The ranges of input levels that can be recorded are shown in Table 2.1. Because of the power ratings of the attenuator resistors, the input level should not exceed 100 volts rms. The dynamic range of input levels to be recorded should be considered in the selection of the potentiometer. Choose the lowest-range potentiometer that will handle the level changes and still keep the pen away from the stops. This will ensure the greatest precision and accuracy of the recorded level changes.

3.2.3 POSITIONING THE PEN AND THE READING CHART.

3.2.3.1 Absolute Level (Millivolts). Set the INPUT ATTENUATOR so that the pen is in the desired position on the paper, ensuring that the pen will stay on the paper during the entire recording. When an auxiliary instrument is to be driven, first run through a "dry recording" with the pen off the paper, to check the range.

TABLE 3.1
CONNECTORS ON RECORDER

<i>Fig. Ref</i>	<i>Name</i>	<i>Type</i>	<i>Function</i>
13, Fig. 2.4	INPUT	Jack-top binding posts (3)	Connection for grounded (red and grounded black) or ungrounded (red and ungrounded black) input.
8, Fig. 2.2	DRIVE UNIT	Multipoint socket	Connection to Drive Unit.
10, Fig. 2.2	DC POT	Multipoint socket	Connection to linear potentiometer.
8, Fig. 2.1	Potentiometer input plug	Type 274 Double Plug and Cable	Connection to potentiometer.

TABLE 3.2
CONTROLS ON THE RECORDER

<i>Fig. Ref</i>	<i>Name</i>	<i>Type</i>	<i>Function</i>
5, Fig. 2.4	INPUT ATTENUATION	7-pos rotary switch	Selects attenuation applied to input signal. Setting is added to db reading on paper to give level of input above 1 mv when 0 db reference is calibrated to 1 mv.
6	WRITING SPEED	4-pos rotary switch	Controls maximum velocity of pen and servo bandwidth.
6	LOWFREQ CUTOFF	4-pos rotary switch	Indicates where low-frequency response is down 1 db.
7	DAMPING	Thumb adjustment	Adjusts overshoot on fastest writing speed (20 in./sec). Turn clockwise to increase damping.
8	CAL	Thumb adjustment	Sets voltage level of 0 db reference. Nominally set for 1 mv.
9	POWER	Toggle switch	Power switch.
10	CHART DRIVE	3-pos rotary switch	Off-forward-reverse control for chart-paper drive mechanism.
11	Paper speed	Levers (2)	Left-hand lever setting times right-hand (multiplier) setting equals number of divisions per minute on 1521-9428 linear paper.* N (neutral) position permits operation by MANUAL SET control.
12	MANUAL SET	Continuous rotary control	Manual paper drive control with lever in N (neutral).
Fig.	Potentiometer selector	4-pos rotary switch	Potentiometer circuit selector.
9, Fig. 2.2	External-motor switch	Toggle switch	In forward position, connects Microswitches to motor.
11, Fig. 2.2	OVERSHOOT	Screwdriver adjustment	Sets overshoot for upscale direction only (increased signal transient).
12, Fig. 2.2	CREEP	Screwdriver adjustment	Removes slow creep in transients.

* or div/hr, depending on motor used.

If the 0-db level has been calibrated to read 1 mv (refer to paragraph 3.2.7), the recorded level will be the sum of the INPUT ATTENUATOR reading and the chart reading (as noted on the front of the potentiometer), in decibels above 1 mv. For example, if, with the INPUT ATTENUATOR set at 40, the pen recorded a level of 3 db, the recorded level would be 43 db above 1 mv.

The level can be converted from db above 1 mv to millivolts by use of db-to-voltage conversion tables such as those found in the General Radio Catalog.

3.2.3.2 Relative Level (in db with respect to arbitrary reference). Many types of measurement do not require an absolute reading in volts, and it is often satisfactory to designate an arbitrary reference as 0 db and to compare chart readings with this level.

This 0-db reference level can be positioned on the chart paper by means of the INPUT ATTENUATOR and CAL controls. If the CAL control is used, 0 db on the paper no longer represents 1 mv. (Refer to paragraph 3.2.7 for readjustment.)

TABLE 3.3
CONTROLS ON RECORDER ACCESSORIES

<i>Fig. Ref</i>	<i>Name</i>	<i>Accessory</i>	<i>Function</i>
14, Fig. 2.4	Drive-Unit Clutch	1521-P10B Drive Unit	Decoupling between recorder chart drive and auxiliary instrument. Auxiliary equipment decoupled in idle position.
2, Fig. 2.4	Idler-Gear Adjustment	1521-P15 Link Unit	Takeup for chain slack.
	Zero (thumbset control)	DC Linear Potentiometer	Adjusts zero input level to any position on recording paper.
	Sensitivity (screwdriver control)	DC Linear Potentiometer	Adjusts full-scale dc sensitivity to 0.8 volt.

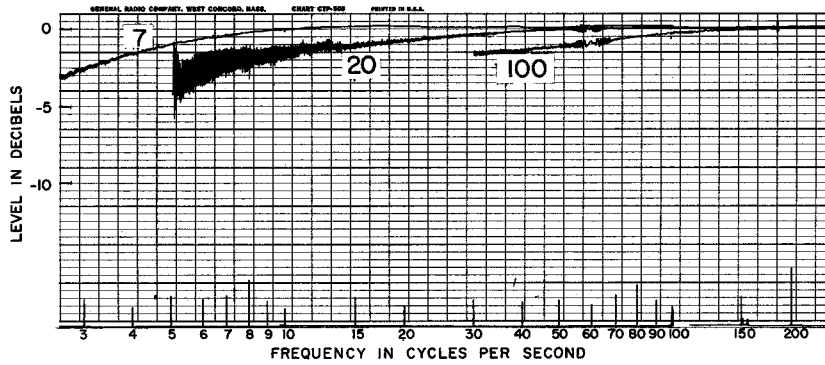

Figure 3.1. Frequency-response plot of the recorder for various positions of the low-frequency cutoff switch.

When a recording is made with respect to an arbitrary reference, the chart reading is simply compared with the reference level. If the INPUT ATTENUATOR setting is then changed, the change in input attenuation must be added to the chart reading.

3.2.4 WRITING SPEED. The WRITING SPEED control adjusts the maximum pen velocity and the maximum bandwidth of the servo system. The fastest writing speed (20 in./sec) is generally the most desirable, where the servo bandwidth is maximum (10 cps). The 10-in./sec speed has about half the servo bandwidth of the 20-in./sec speed, and is the fastest speed possible without overshoot. (However, even at 20 in./sec, overshoot is usually negligible; refer to paragraph 3.2.5.) The slower speeds (3 in./sec and 1 in./sec) are used where unwanted noise or fluctuations are to be filtered from the recording.

3.2.5 LOW-FREQUENCY CUTOFF. The WRITING SPEED switch also changes the low-frequency cutoff. This information is engraved on the front panel. The engraved frequency corresponds to the point where the response is less than 1 db down. Figure 3.1 shows the frequency-response plot of the recorder for various positions of the low-frequency cutoff switch. Figure 3.2 shows the low-frequency response to a 1/3-octave

band of pink noise, with a writing speed of 1 inch/second. When measuring narrow-band noise, turn the CREEP control fully clockwise and the OVERSHOOT control fully counterclockwise.

3.2.6 DAMPING. The overshoot on the fastest speed (20 in./sec) is normally set to one chart division on Types 1521-9428, -9463, and -9429 Paper, and two divisions on Type 1521-9427 Paper, for step changes at the input. This is the preferred writing speed, (except when signals below 100 cps are being recorded) since changes in level are not normally instantaneous. Thus the overshoot is negligible, with optimum response to level changes. The overshoot can be varied by means of the DAMPING control. Turning this thumbset adjustment clockwise increases the damping, thus decreasing the amount of overshoot. If the overshoot is not symmetrical, refer to paragraph 6.3.2.

To observe the overshoot, apply a constant-level input signal, turn the CHART DRIVE switch on, and change the INPUT ATTENUATOR setting by 10 db.

NOTE

If the DAMPING setting is decreased beyond a certain point, oscillation will occur. Correct by turning the DAMPING adjustment clockwise.

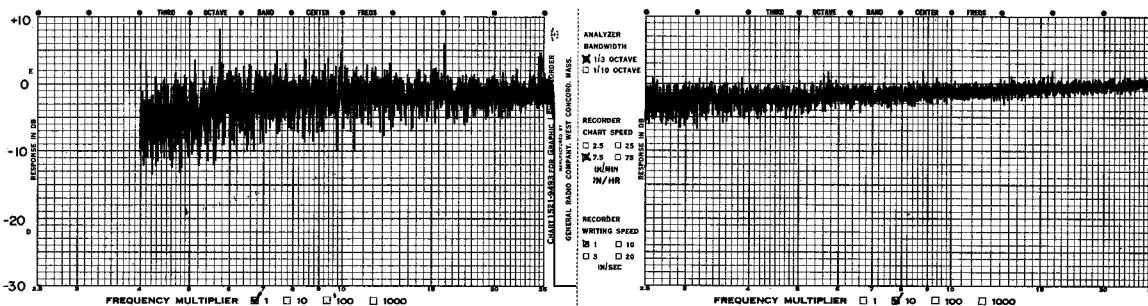

Figure 3.2. Low-frequency response to a 1/3-octave band of pink noise, with a writing speed of 1 inch/second.

3.2.7 RECORDING. Move the gear-shift levers to the desired speed and turn the motor on by turning the CHART DRIVE switch to FWD. The speed in inches/minute or inches/hour is engraved beside the levers.

If it becomes necessary to shut off the motor to stop the chart drive, simply shift the right-hand lever to N (neutral). However, do not shift the left gear-shift lever while the chart is moving.

When the paper is moving, place the pen in its writing position and start recording.

NOTE

Refer to paragraph 2.1.3 for instructions covering proper use of the marker (pen).

3.2.8 CALIBRATING 0-DB LEVEL TO 1 MV. In order to calibrate the recorder so that the 0-db settings of the INPUT ATTENUATOR switch and pen both correspond to 1mv, proceed as follows:

a. Connect a stable oscillator to the input of the recorder. Set this oscillator to a frequency well within the pass band of the recorder (e.g., 1 kc). The 60-cps line will do if it is attenuated externally. (Refer to Table 2.1.)

b. Monitor this input voltage with an ac rms voltmeter. (Many oscillators, such as the Type 1304-B Beat-Frequency Audio Generator, include a voltmeter for monitoring the output.) The accuracy of the voltmeter used will limit the calibration accuracy. A voltmeter accuracy of five percent corresponds to a calibration accuracy of 0.5 db.

c. Adjust the oscillator output to produce a convenient voltmeter reading.

d. Noting which line on the chart paper corresponds to 0 db, use the INPUT ATTENUATION and CAL controls to set the pen in accordance with the voltmeter reading. For instance, if the voltmeter reads 1 volt (60 db above 1 mv), set the INPUT ATTENUATION control to 40 db and, using the CAL control, position the pen on the 20-db line on the paper.

3.3 LEVEL-VS-TIME RECORDING. Recordings of level vs time can be made on the Type 1521-9428 Chart Paper supplied with the instrument. To calibrate the time scale, simply take the reciprocal of the paper speed. Thus, with a chart speed of 75 inches per minute, each inch equals 1/75 minute, or 0.8 second.

It is advisable to use a fast writing speed with fast paper speeds and a slow writing speed with slow paper speeds, so that the recording can be read easily. For instance, a sound-level measurement versus time would show very little if the fastest writing speed were used with the slowest paper speed.

3.4 LEVEL-VS-FREQUENCY RECORDING.

3.4.1 GENERAL. After the necessary Drive and Link Units have been installed (refer to paragraphs 2.2.2 and 2.2.3), the frequency dial of the driven instrument must be synchronized with the appropriate recording paper. (Refer to paragraph 1.5.) The synchronization procedure is as follows:

a. Throw the Type 1521-P10B Drive Unit clutch out (idle position).

b. Set the right-hand chart-speed lever to N, and turn the MANUAL SET control to set the chart paper to the desired low-frequency limit.

c. Set the right-hand chart-speed lever to x10 or x1.

d. Turn the oscillator dial to the desired low-frequency limit (corresponding to the recorder paper).

e. Throw the clutch into the NORMAL DRIVE position for instruments with dial stops (the slip clutch on the Type 1521-P10B protects the dial stop) or into the NON-SLIP position for instruments without dial stops or where large driving torques are required.

CAUTION

The NON-SLIP position should not be used with external instruments that have dial stops, since, in this case, no protection is provided.

f. Throw the external motor switch (9, Figure 2.2) toward the front panel, to connect the Microswitches to the motor.

g. Position the reverse limit Microswitch stops, (4, Figure 2.4) so that they just turn off the recorder motor in the REV drive position.

h. Set the CHART DRIVE switch to FWD and sweep through the desired frequency range. Set the forward limit switch to turn the recorder motor off at the desired high-frequency limit.

i. Sweep back and forth, checking the frequency limits at the paper speed to be used. Also check the chart and dial frequencies against each other.

NOTE

The Type 760-A Sound Analyzer, the Type 1564-A Sound and Vibration Analyzer, the Type 1900-A Wave Analyzer, and some models of the Type 1304-B Beat-Frequency Audio Generator have frequency dials that can be swept through 360°. Turning the external-motor switch toward the rear of the instrument will disconnect the limit switches for 360-degree rotation.



The equipment is now ready for recording. With the pen up, check that it will stay within the useful recording range during the frequency sweep. If necessary, change the INPUT ATTENUATOR setting or install a wider-range potentiometer.

When making the first recording, be careful not to sweep the auxiliary instrument too fast or there will be errors in the recording. If slow writing speeds are to be used to filter noise, it is advisable to use a slow paper speed as well. (Remember that slow writing speeds limit the ability of the recorder to respond to level changes.)

3.4.2 OPERATION WITH TYPE 1304-B BEAT-FREQUENCY AUDIO GENERATOR. The Type 1521-B Graphic Level Recorder and the Type 1304-B Beat-Frequency Audio Generator, with their accessories, are included in the Type 1350-A Generator-Recorder Assembly. The Generator is an excellent signal source with which to test the response of various systems. The output of the Type 1304-B is fed to the system under test, and the system output is recorded. The voltage variations of the Type 1304-B are less than ± 0.25 db between 20 cps and 20 kc.

On later models of the Type 1304-B, where the frequency dial can be swept 360° , production tests for frequency response can be made with no lost time. The motor is left running, and each component is plugged into the jig during the blank space on the Type 1304-B dial.

3.4.3 OPERATION WITH TYPES 1554-A and 1564-A SOUND AND VIBRATION ANALYZERS AND TYPE 760 SOUND ANALYZER. Analysis of noise or of electrical signals versus frequency can be made quite conveniently by means of the Type 1564-A Sound and Vibration Analyzer (or the Type 760 Sound Analyzer, now obsolete, or Type 1554-A Sound and Vibration Analyzer, also obsolete) connected to the recorder. The Type 1564-A Sound and Vibration Analyzer and the recorder, with their accessories, form the Type 1911-A Recording

Sound and Vibration Analyzer. The signal to be analyzed is connected to the input of the analyzer, with the analyzer output coupled to the recorder. When using the analyzer for noise measurement, turn the CREEP control fully clockwise and the OVERSHOOT control fully counterclockwise.

Extreme care is necessary when the analyzer is driven, especially at lower frequencies. A fast sweep will cause errors in the recorded amplitude, and in the center frequency and effective bandwidth of the filter. Table 3.4 gives the maximum recommended sweep speeds for the Types 760, 1564, and 1554 Sound Analyzers. The sweep speeds in Table 3.4 give an error in magnitude less than 2% of full scale (0.8 db for the 40-db potentiometer) with one exception. The lowest band of the Type 760 contributes a magnitude error of 0.8 db at 25 cps when a 20-db potentiometer is used and when the analyzer is swept at the lowest possible paper speed available with the high-speed motor. (Because of this error, the Type 1521-P23 medium-speed motor is recommended for use with analyzers.)

The Type 760 can be swept 360° , and a continuous analysis can therefore be made from 25 cps to 7.5 kc. Starting at 25 cps, the recording is made in the first half decade to 75 cps. During the white range of the chart paper after 75 cps, the next range button on the analyzer is pressed. This is repeated on successive ranges until the entire frequency range is covered.

The Type 1564-A can be swept through 360° and, in addition, the range switching is accomplished automatically as the recorder sweeps the analyzer through the blank portion of the dial.

3.4.4 OPERATION WITH TYPE 1900-A WAVE ANALYZER. The Type 1910-A Recording Wave Analyzer (Figure 3.3) consists of the Type 1900-A Wave Analyzer and the Type 1521-B Graphic Level Recorder. This combination makes possible the automatic recording of spectra in the frequency range of 20 to 50,000 cps. Unlike the sound analyzers, the wave analyzer offers a choice of three

TABLE 3.4.
MAXIMUM RECOMMENDED SWEEP SPEEDS FOR THE TYPE 760-B
SOUND ANALYZER AND TYPES 1554 and 1564 SOUND AND VIBRATION ANALYZERS.

Recommended Max Sweep Speed (Inches/Min)

Frequency Band	20-db Pot.			40-db Pot.			80-db Pot.		
	760-B	1564 and 1554, N.B.*	1564 and 1554, 1/3 OCT.	760-B	1564 and 1554, N.B.*	1564 and 1554, 1/3 OCT.	760-B	1564 and 1554, N.B.*	1564 and 1554, 1/3 OCT.
25 - 250 cps	2.5 2.5	7.5	7.5	2.5 2.5	7.5	7.5	2.5 2.5	7.5	7.5
250 cps - 2.5 kc	7.5 7.5	25	25	7.5 7.5	25	25	7.5 25	25	25
2.5 - 25 kc	7.5 —	25	25	7.5 —	25	25	25 —	25	25

*N.B. indicates NARROW BAND

TABLE 3.5
INDUSTRY SCALE FACTORS

Industry Standard	Scale Factor db/decade	Decade Length (inches) for Type 1304 Generator	Sprocket (teeth)	Pot. (db)
Institute of High-Fidelity Manufacturers	20	2.0	16	40
Proposed International Standard	25	2.5	10	40
Electronic Industries Association (1521-P14)	30	3.0	24	40
Institute of High-Fidelity Manufacturers	20	4.0	32	20
Hearing-Aid Industry	45	4.5	36	40
Proposed International Standard	50	5.0	40	40
Proposed International Standard	50	5.0 (Type 1564)	16	40

fixed bandwidths: 3, 10, or 50 cps. For a detailed description of this analyzer and its use with the recorder, refer to the General Radio Catalog and the Operating Instructions for the Type 1900-A Wave Analyzer. When using the analyzer for noise measurement, turn the CREEP control fully clockwise and the OVERSHOOT control fully counterclockwise.

WARNING

Do not use the high-speed motor with the Type 1900-A Wave Analyzer; use either the slow-speed or the medium-speed motor. To change motors, refer to paragraph 2.1.5.

3.4.5 CHOICE OF SCALE FACTORS FOR RECORDING LEVEL VS FREQUENCY. Many different standards for the length of a frequency decade on a logarithmic chart and for the scale factor are now in use. The scale factor is the product of the db per inch on the vertical

scale and the inches per decade of frequency on the horizontal scale, expressed in db per decade. The Type 1521-P15 Link Unit provides one of the standards commonly accepted in the United States. The Type 1521-P16 Sprocket Kit, for use with the Type 1521-P15, covers most of the current standards. Table 3.5 lists some of these standards with the corresponding scale factors obtained with the various sprockets included in the Type 1521-P16 Sprocket Kit. Paper for the 24-tooth sprocket supplied with the Type 1521-P15 is available from General Radio. Although we currently catalog chart paper for only the 30- and 50-db/decade scale factors, we shall be glad to recommend other suppliers to users sending us a description of the chart desired, including decade length, vertical scale, etc.

3.5 DC RECORDING. When the Type 1521-P4 Linear Potentiometer is installed and the DAMPING control is adjusted for two divisions of overshoot, the waveforms of low-frequency signals can be recorded. (Refer to paragraph 4.10 for bandwidth limitations.) The procedure for adjusting the DAMPING control is as follows:

- a. Using the zero thumb control on the front of the dc potentiometer, set the zero input position of the pen about five divisions from the left side of the chart.
- b. Set the WRITING SPEED control to 20 in./sec and the INPUT ATTENUATOR switch to 0.
- c. Apply about 0.5 volt dc to the INPUT connectors (e.g., a 1.5-volt dry cell with 2000 ohms in series).
- d. Turn the chart drive on.
- e. Switch the INPUT ATTENUATOR back and forth from 0 to 10 db.
- f. Adjust the DAMPING control so that the overshoot is two divisions on the Type 1521-9428 Paper. (Refer to paragraph 4.10 for a discussion of overshoot and bandwidth.)

The full-scale sensitivity is normally set to 0.8 volt for use with 40-division paper. This can be changed to 1 volt full scale for 50-division paper (Type 1521-9466) by means of the control on the top of the potentiometer.

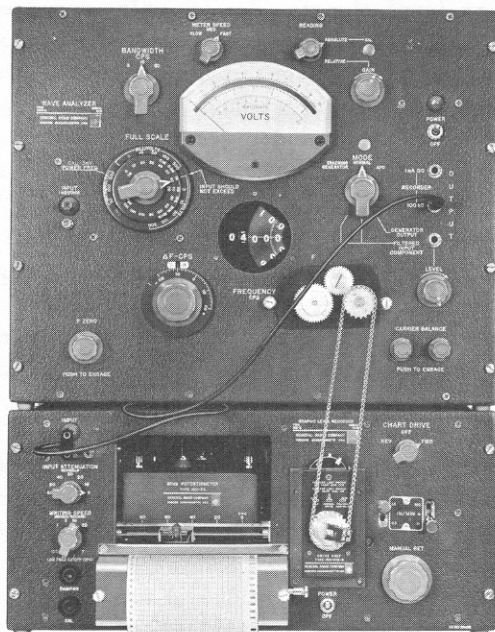

Figure 3.3. Type 1910-A Recording Wave Analyzer consisting of the Type 1900-A Wave Analyzer and the recorder.



SECTION 4

PRINCIPLES OF OPERATION

4.1 GENERAL. The general principle of operation is described in paragraph 1.2. This section will describe each component (see the block diagram, Figure 1.2), and will discuss sources of measurement error so that the user may understand the limitations of the instrument and thereby achieve accurate recordings.

4.2 INPUT CIRCUIT AND AC AMPLIFIER. The calibrated input attenuator has a 60-db range, in six 10-db steps. The input impedance is 10,000 ohms for all attenuator settings. The 10,000-ohm potentiometer represents a compromise between the desire for high input impedance and the desire to minimize capacitive loading effects of the ac amplifier.

The ac amplifier comprises an emitter-follower input, four stages of gain, and a phase-inverter stage to drive the detector. The high input impedance of the emitter follower minimizes its loading effect on the potentiometer. The amplifier gain is approximately 1000, and can be adjusted to exactly 1000, by means of a gain control, for measurement of absolute levels.

The four stages of gain are in two two-stage sections. In each section, a large amount of dc feedback stabilizes transistor operating points against temperature changes. There is also enough ac negative feedback to insure stability of calibration. A regulated power supply minimizes the effects of line-voltage variations.

The dynamic range of recorded signals depends upon the potentiometer, since ac voltage levels within the amplifier are constant at null. (Refer to paragraph 1.2.) However, to allow faithful reproduction of input signals with a peak-to-rms ratio of 5 to 1, the ac amplifier has a 15-db dynamic range.

4.3 DETECTOR. A full-wave detector is used in the recorder, minimizing the effects of ripple for low-frequency inputs. Its quasi-rms response¹ closely approximates true rms for commonly encountered waveforms. The output is within 0.25 db of true rms for sine waves, multiple sine waves, square waves, and white noise.

Since the potentiometer output is linear in db rather than in volts, the change in output voltage of the detector is significantly different for increasing and decreasing input signals. For example, a sudden 10-db increase would momentarily produce 3.16 volts, a change of 2.16 volts (error voltage) from its normal 1-volt value; a 10-db decrease would produce 0.316 volt, a change of -0.684 volt. To maintain comparable step responses in the two directions for such vastly differing signals, diode limiters are incorporated at the output of the detector. The level of limiting is set to produce similar transient responses for increasing or decreasing levels of at least 20 db (refer to paragraph 6.3). When adjusted correctly, the limiters will limit both halves of the symmetrical detector circuit to about 2 volts. Thus the error voltage will be limited to ± 1 volt.

4.4 PEN DRIVE CIRCUIT. The detector output is compared by emitter followers with a 1-volt dc reference obtained from the regulated 18-volt supply. An attenuator after the emitter followers changes the loop gain according to the potentiometer used. This is necessary because a 0.1-inch displacement from null on the

¹E.E. Gross, "Improved Performance Plus a New Look for the Sound-Level Meter", *GENERAL RADIO EXPERIMENTER*, Vol. 32, No. 17, October, 1958.

80-db potentiometer will produce a 2-db change in level, a 0.26-volt error voltage, while the same displacement on a 40-db potentiometer will produce a 1-db change in level, a 0.12-volt error voltage. Thus an attenuation factor of 2 is required when the 40-db potentiometer replaces the 20-db unit, and an attenuation factor of 4 when the 80-db potentiometer replaces the 20-db unit. A velocity feedback signal (see Figure 1.2) is also injected at this point. The sum of the error voltage (attenuated for the 40- and 80-db potentiometers) and the velocity feedback voltage is then amplified by a push-pull dc amplifier, drift-compensated by negative feedback. Two power transistors produce current through the drive coil or servo motor.

The servo motor consists of a center-tapped drive coil (2, Figure 4.1) wound on a lightweight lucite form, which is positioned in the uniform magnetic field of an Alnico permanent magnet (4, Figure 4.1). The interaction between the current in the coil and the field from the permanent magnet is used to move the coil in a direction to reduce the error voltage. When the coil is correctly positioned, the error voltage and the current in the coil become zero, and there is no further force on the coil. Thereafter, any slight movement from the correct null position will produce an electrical restoring force on the coil. Full current flows through the coil for a displacement of less than 1/32 inch from the true null, resulting in a high degree of static accuracy (refer to paragraph 4.9). (This ability of the servo to provide full current in the drive coil for a displacement of less than 1/32 inch from null should not be confused with dynamic error. When the coil assembly is moving, velocity feedback reduces the servo loop gain and thus increases the error a proportional amount.)

The pen and the potentiometer wiper arm are mounted directly on the coil structure, so that backlash is negligible.

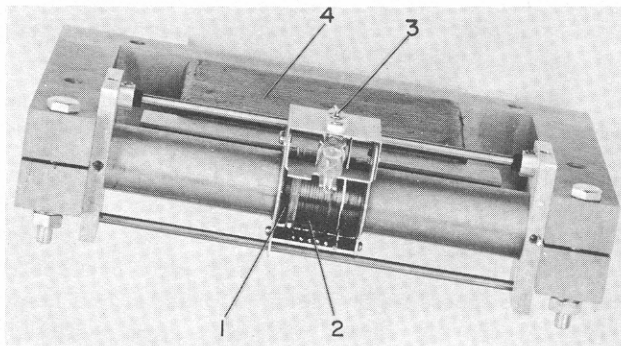

Figure 4.1. View of magnetic structure and pen motor.

- 1. Feedback coil
- 2. Drive coil
- 3. Potentiometer wiper arm
- 4. Magnet

4.5 VELOCITY FEEDBACK. A second winding on the drive-coil structure generates a voltage proportional to the coil velocity (see 1, Figure 4.1). This damping voltage is fed to the input of the dc amplifier to reduce the servo loop gain at high frequencies and the time constant of the drive-coil circuit. As a result, an adequate degree of stabilization can be obtained consistent with a reasonable bandwidth of the pen servo and the desired static accuracy. Slower writing speeds are obtained as the amount of damping voltage is increased.

4.6 LOGARITHMIC POTENTIOMETERS. The potentiometers have winding forms shaped to obtain a scale linear in db. Padding resistors tapped to the winding permit use of the same size wire throughout the potentiometer; a high degree of resolution is thus obtained at all positions of the slider.

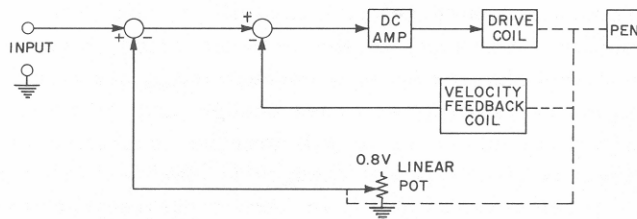

Figure 4.2. Block diagram of servo loop for dc recording.

4.7 DC RECORDING. Use of the linear potentiometer converts the Type 1521-B into a dc recorder. Figure 4.2 is a block diagram of the recorder servo loop for dc recording. The ac amplifier is bypassed and the input is compared with a dc voltage tapped off a linear potentiometer. The voltage on this potentiometer limits the full-scale sensitivity to 0.8 volt. The input impedance is limited to 1 kilohm owing to the base current of the input transistors. This current changes with temperature, but the change contributes negligible error with a 1000-ohm input impedance. The impedance can be increased if the effects of the current are included in the zero adjustment of the recorder. The input impedance can also be lowered, reducing sensitivity and drift. The low impedance may be more useful for recording current.

A zero adjustment (R19) adds a dc voltage in series with the input. Thus the zero position (input voltage zero) can be set to any point on the chart paper.

4.8 TRANSIENT RESPONSE AND DYNAMIC ERROR. The ability of the recorder to reproduce faithfully changes in the input level is a function of the saturated velocity

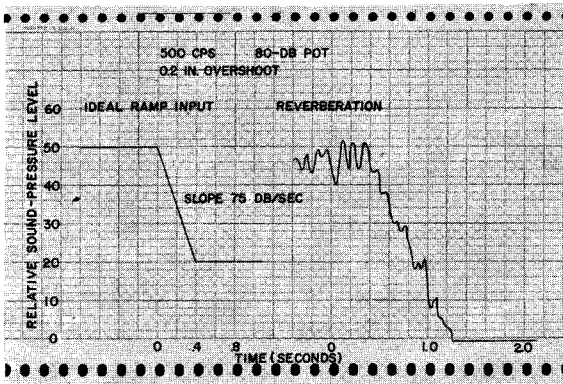

Figure 4.3. Recording of ramp-type input.

(maximum writing speed), bandwidth, and degree of stability of the servo system. The application of a large step change in input level is often used to show the maximum saturated velocity capabilities and degree of stability (overshoot) of the recorder servo. However, most level changes actually encountered by the recorder will not be as abrupt as a step change, and the dynamic performance of the servo will here be considered with respect to other types of changes in input level that do not produce saturation. Two such types are the ramp (constant rate of level change) input and the sine wave.

The ramp-type input is often encountered in practice (as, for instance, in reverberation-time measurements, see Figure 4.3). As the slope of the ramp increases, a point is reached where the error signal no longer remains constant; this is the limit of the linear operating range of the recorder. This maximum slope corresponds to the maximum writing speed of the recorder for a step-type input.

The response of the recorder to sine-wave inputs is discussed in paragraph 4.10.

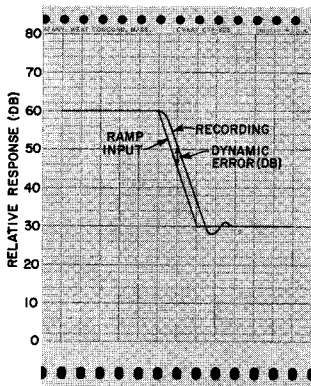

Figure 4.4. Dynamic error for ideal ramp input.

The information in this section will be directly applicable only to ramp inputs, but will indicate the ability of the recorder to follow complex transients. Thus, it shows the effect of writing speed and potentiometer value (20, 40, or 80 db) on the speed capabilities of the recorder.

A servo-type recorder requires a finite position error in order to drive the coil at a constant velocity. Here it is well to consider the difference between static error and dynamic error. Static error, discussed in paragraph 4.9, is the small error required to move a stationary pen in order to overcome static friction. The dynamic error is measured when the pen is moving at a constant velocity. It is the difference between the true input level and pen position at one instant of time. It will always be much larger than the static error, since the velocity feedback voltage subtracts from the error voltage at the output of the detector. Dynamic error is measured at the detector output, and is the difference between the rectified voltage from the ac amplifier and the 1-volt reference voltage. This error can be referred back to the

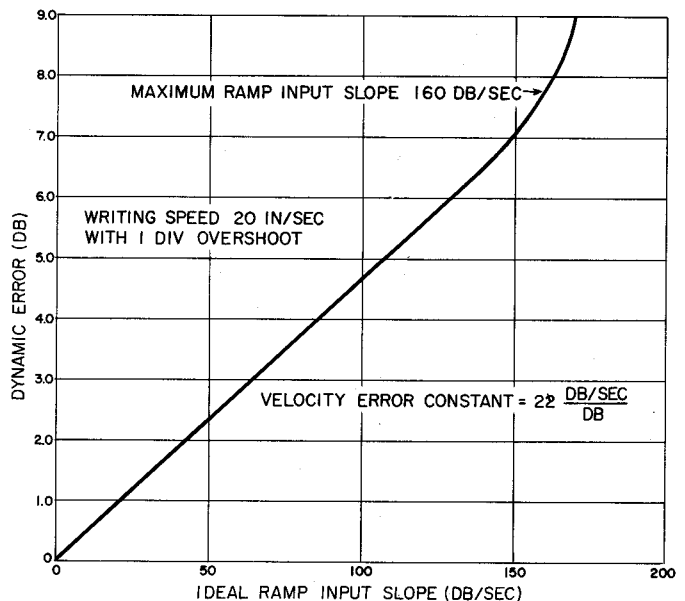

Figure 4.5. Dynamic error for 20-, 40-, and 80-db potentiometers.

input of the ac amplifier so that the actual error on the recording can be indicated in db. Thus, a 0.1-volt error at the detector would be a 1-db error between the input and the recording on the chart paper at one instant of time. Figure 4.4 shows what this error would look like on the chart paper for an ideal ramp input. It should be emphasized that this error is not necessarily harmful, since for a simple ramp input it simply implies a delay in time.

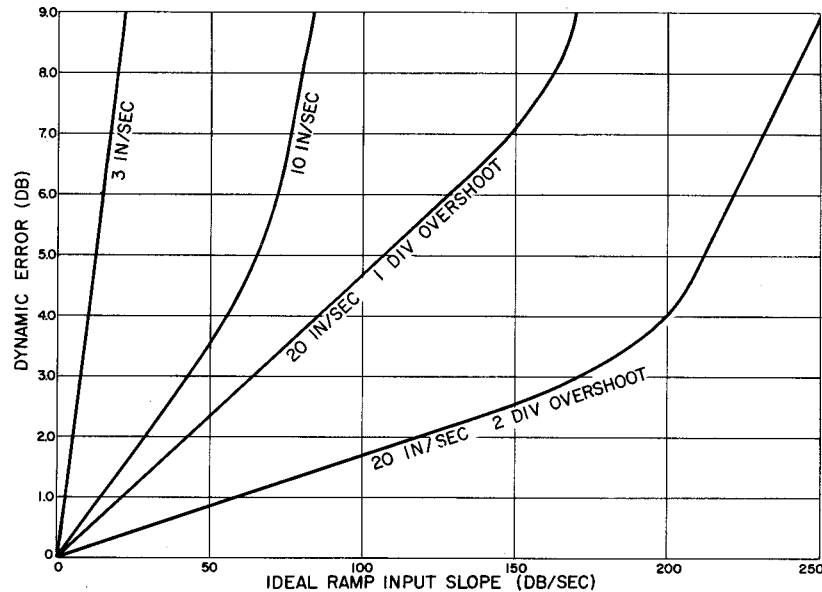

Figure 4.6. Dynamic error for various writing speeds (with 40-db potentiometer).

The servo in the Type 1521-B Recorder develops a constant dynamic error for a constant-velocity input. Thus with a ramp input, a constant error will be observed except at the points of acceleration and deceleration (see Figure 4.4). The ratio of the input velocity to this constant error is sometimes referred to as the velocity-error constant (K_v). This velocity-error constant is the same for all three potentiometers. One must remember, however, to express the error in db and the velocity in db per second, or error in inches and velocity in inches per second. The graph in Figure 4.5 shows the error (db) for a ramp input.

The error is also a function of the WRITING SPEED control setting and the adjustment of the DAMPING control. Figure 4.6 shows the error for the 40-db potentiometer for different settings of these two controls. These curves show that a little overshoot, if it can be tolerated, will help achieve low error. The overshoot has been set at the factory to 0.1 inch (1 div on Type 1521-9428 chart paper) which we consider optimum for most measurements. If more overshoot can be tolerated, such as in reverberation-time measurements, decreased damping will reduce the dynamic error. Also, it will increase the maximum input ramp velocity for the 40-db and 80-db potentiometers (explained in the following paragraphs).

The pen velocity is limited by the saturated current condition of the output transistors. Thus, if the constant-velocity ramp input increases beyond this saturation velocity, the pen will not follow the input and the

error will increase. This is noticeable as the ramp input velocity is increased beyond 30 in./sec for the 20-db potentiometer, when the error increases very rapidly.

The maximum ramp input in inches per second that the recorder can follow is less for the 40- and 80-db potentiometers than for the 20-db unit because of the greater attenuation required for a constant loop gain. Increased attenuation occurring after limiting of the detector output reduces the maximum input voltage to the dc amplifier. Because this voltage is reduced, the drive coil moves at a slower velocity so that the velocity feedback voltage does not exceed the input voltage. Thus the maximum ramp input in db per second is the same for all potentiometers.

How does this limit on the ramp input affect the limit on reverberation time? This will depend on the information desired from the reverberation measurement. In many instances, the only information required is the reverberation time -- the time for a 60-db decay in sound level (refer to paragraph 5.5). Here the maximum ramp input mentioned previously limits the minimum reverberation time that can be measured to 0.3 second. However, a reverberation decay is not an idealized ramp decay, but contains superimposed oscillations caused by adjacent room modes beating against one another. The indication of these beats may be useful in analyzing the acoustic properties of the room.¹ The minimum reverberation time that can be measured with these beats

¹C. L. S. Gilford, "The Acoustic Design of Talk Studios and Listening Rooms", *THE PROCEEDINGS OF THE INSTITUTE OF ELECTRICAL ENGINEERS*, Vol. 106, Part B, No. 27, May 1959, pp 249, 250.

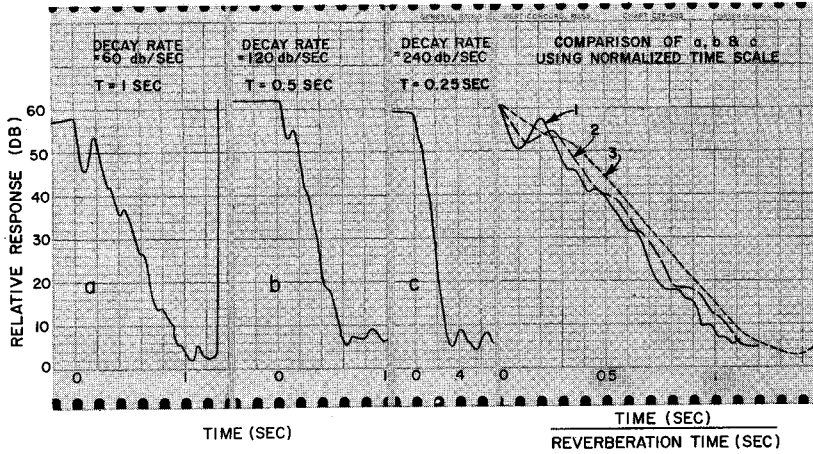

Figure 4.7. Minimum-reverberation-time measurements. Effective reverberation time decreased by use of multiple-speed tape recorder.

shown is 0.5 second (see Figure 4.7). For the measurement shown in Figure 4.7a, a reverberation decay was recorded on a tape recorder. It was then played back at slower and faster tape speeds to simulate longer and shorter reverberation times, with the Type 1521-B recording the decay. When the time scale is matched for each decay, there is little error in the average slope (proportional to reverberation time), yet the beats are filtered out by the Recorder as the effective reverberation time is decreased (Figure 4.7, b and c). Note that although there is dynamic error, the average slope follows the ramp decay, delayed in time.

4.9 ACCURACY OF NULL (STATIC ACCURACY).

4.9.1 GENERAL. The accuracy of the null position depends upon many independent factors. Despite the many influences, at room temperature the error is less than one percent of full scale, if the input frequency is well within the pass band of the amplifier. The errors determining the total accuracy of the recording are discussed in the following paragraphs.

4.9.2 DEAD SPAN. Dead span is the region where there is not enough current in the drive coil to overcome the static friction and move the coil to the true null position. The gain of the dc amplifier of the Type 1521-B is sufficient to reduce the dead span to less than 1/64 inch. Thus the error is less than ±0.2 percent of full scale (±0.08 db on the 40-db potentiometer).

4.9.3 POTENTIOMETER ACCURACY. The rated accuracy of the potentiometers is one percent of full scale, but the accuracy of the 20- and 40-db potentiometers is usually better than 0.5 percent of full scale. The resolution of the potentiometer contributes negligible error compared with the dead-span error mentioned previously.

4.9.4 FREQUENCY ERROR. The frequency response of the ac amplifier may contribute errors at frequencies near the low-frequency cutoff and near 200 kc. The amplifier is flat within 3 db from 100 cps to 200 kc. The low-frequency response is shown in Figure 3.1 for the various positions of the WRITING SPEED control. It is down less than 1 db at 7 cps for the two slowest writing speeds. At frequencies above 200 kc, there are slight errors in the attenuator and also in the potentiometer due to capacitive loading on the wiper arm. These errors are less than 1.5 db at 200 kc. For extreme accuracy, a response recording of the oscillator can be used as the basis of compensating recordings of devices under test. For example, if the recorder ac amplifier rolled off 1 db at 20 cps, 1 db added to the final recording would remove frequency errors caused by the recorder.

4.9.5 TEMPERATURE EFFECTS. Table 4.1 shows the drift for a typical recorder for the temperature ranges indicated.

TABLE 4.1
~DRIFT WITH TEMPERATURE,
FOR A TYPICAL RECORDER.

Potentiometer	Drift (max variation, min to max reading, in % of full scale)	Temperature Range (degrees)
DC Linear	2.5%	15 - 45 C
20, 40, 80 db	1.0%	15 - 33 C
20, 40, 80 db	2.5%	0 - 45 C

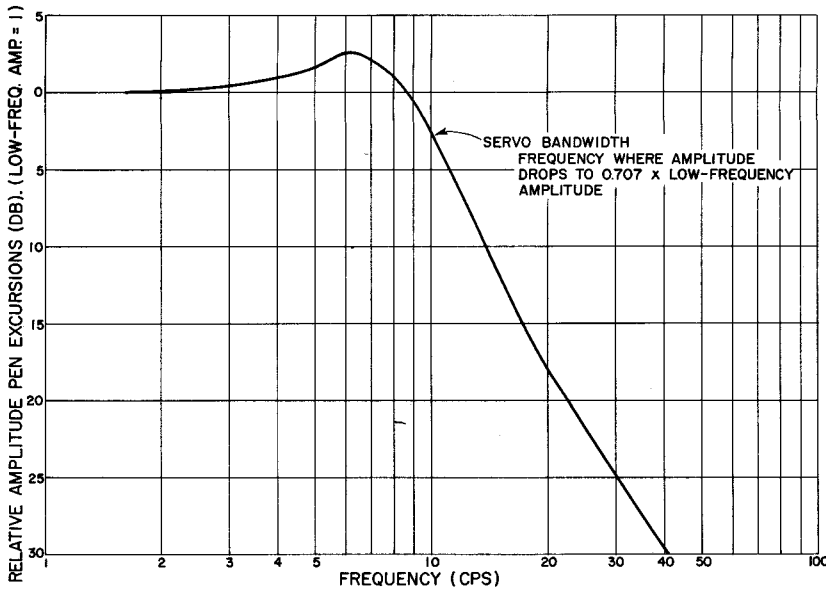

Figure 4.8. Servo frequency response.

4.10 SERVO BANDWIDTH. Servo bandwidth in a level recorder is defined for the motion of the pen, and is independent of the frequency response of the ac amplifier (7 cps to 200 kc). The servo acts as a low-pass filter, with the pen following level variations up to frequency cutoff. The cutoff frequency or servo bandwidth is the frequency at which the amplitude of the pen excursions drops to 0.707 times the amplitude at low frequencies (see Figure 4.8). The servo bandwidth is a useful indication of the recorder capabilities for small variations in amplitude.

The servo bandwidth of the dc potentiometer is easily measured. A low-frequency signal is fed directly into the recorder input, and the cutoff frequency is measured. This is somewhat more difficult with the logarithmic potentiometers, since a high-frequency signal must be modulated with a low-frequency signal.

Servo bandwidth depends upon the amplitude of the low-frequency pen excursions. If a plot is made of bandwidth versus amplitude of excursions, the bandwidth will remain constant as the amplitude is increased until writing speed becomes a limitation. (This characteristic is shown in Figure 4.9 for all four potentiometers.) For a given frequency the maximum slope of a sine wave increases directly with amplitude. Because of the recorder writing-speed limitation, the servo bandwidth will decrease as the amplitude increases. Recorded signals above this frequency will not only have an amplitude error, but will be very distorted. The amplitude at which writing speed becomes a limitation increases as the dynamic range of the potentiometer decreases. (Refer to Figure 4.9.) But this amplitude, when converted to db, remains constant for the logarithmic potentiometers.

The maximum small-signal bandwidth varies directly with the setting of the DAMPING control. In Figure 4.9, when the overshoot was increased from 1 to 1-3/4 divisions, the bandwidth increased 40%. This increase in bandwidth, in conjunction with the increase in maximum ramp slope (refer to paragraph 4.8) is useful for reverberation-time measurements.

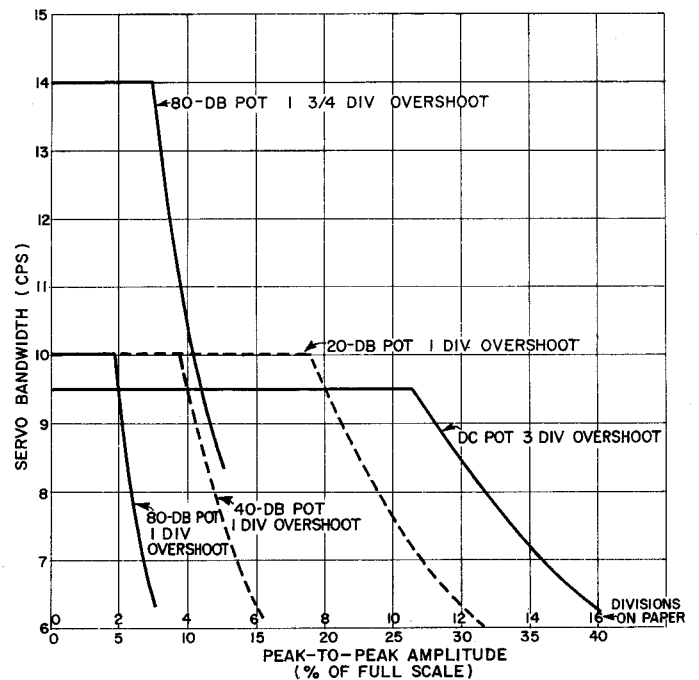

Figure 4.9. Servo bandwidth vs amplitude of excursions.



TABLE 4.2
SERVO BANDWIDTH FOR SLOW WRITING SPEEDS
(Typical Recorder)

Position of Writing Speed Control	Servo Bandwidth (cps)	
	20-, 40-, 80-db pots	DC pot
10	5.0	1.2
3	0.80	0.45
1	0.25	0.20

The servo bandwidth decreases as writing speed is decreased. This is shown in Table 4.2 for a typical recorder. There is no amplitude limitation for the slower writing speeds, the bandwidth remaining constant even for full-scale excursions of the pen.

4.11 HIGH-Q ANALYZERS. With high-Q analyzers, there are some fundamental problems that are independent of recorder characteristics. If the analyzer is swept too fast, errors will occur in the magnitude, frequency, and effective bandwidth of the analyzer.

Figure 4.10 shows a recording of a frequency analysis made with a fixed-frequency input to the Type 760-B Sound Analyzer. This shows a comparison of the correct recording and a recording in which the Analyzer was swept too fast. Note the error in magnitude, shift in center frequency, and increased effective bandwidth of the filter. The oscillations occurring on the decay side indicate that the Analyzer was swept too fast. These oscillations are caused by beating between the input frequency and the frequency of the high-Q circuit after energy has been stored.

The rate at which an analyzer may be swept for a given error is proportional to the square of the filter bandwidth.¹ Thus for a constant-Q filter, the sweep speed in cycles per second for a given error increases as the tuned frequency is increased. The General Radio

analyzers described in this manual are constant-Q filters. Thus the low-frequency ranges should be swept fairly slowly. Table 4.3 shows the errors measured for the Types 760-B, 1564-A, and 1554-A Analyzers at the maximum recommended sweep speeds given in Table 3.4.

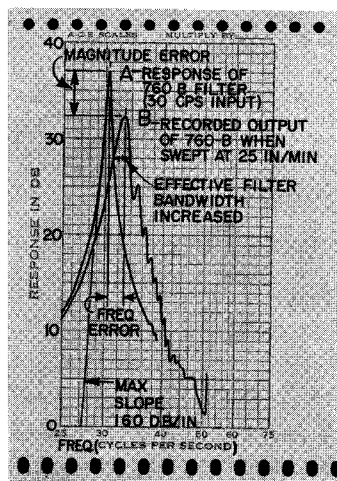

Figure 4.10. Errors from sweeping high-Q analyzer too fast.

In analysis at higher frequencies (above 750 cps with the Type 760-B), the sweep speed is limited by the writing speed limitations of the recorder. The maximum slope of the curve shown in Figure 4.10 is 160 db/inch. The shape of this curve on the chart will be relatively constant with frequency, since the frequency scale is approximately logarithmic. At a paper speed of 30 div/min, this slope would correspond to 20 db/sec. The pen would ordinarily follow such a slope without any difficulty; with a high-Q filter, however, the slope quickly changes near the filter peak from +20 db/sec to -20 db/sec as the analyzer is swept by the input frequency. Thus the dynamic error (refer to paragraph 4.8) shows up directly as a level error on the recording. This error places a final limitation on the sweep speed if the pen has to travel over large distances.

TABLE 4.3
ERRORS AT MAXIMUM RECOMMENDED SWEEP SPEEDS

Instrument Type Number	Frequency Band (CPS)	Sweep Speed (Chart Div/Min)	Magnitude Error (DB)	Frequency Error (% of f_0)	% Increase in Filter Bandwidth
760-B	25 - 75	10	-0.8	+1.3	+70
	75 - 250	10	-0.25	+2.0	small
	250 - 750	30	-0.3	+0.7	+20
	750 - 2500	30	-0.15	+0.7	small
	2500 - 7500	30	-0.15	+0.7	small
1564-A and 1554-A Narrow Band	25 - 250	30	0	+0.8	0
	250 - 2500	100	0	+0.5	+ 8
	2500 - 25,000	100	0	+0.3	+ 2

Potentiometer = 40 db; Writing Speed at 20 in./sec. Damping adjusted for 0-db overshoot.

SECTION 5

APPLICATIONS

5.1 GENERAL. This section describes some of the many measurements possible with the Graphic Level Recorder. Although General Radio equipment is recommended, suitable equipment of other manufacturers may be used, except for equipment whose dials are to be coupled to the recorder by the standard link units. Link units, as well as recorder paper, have been designed specifically for use with General Radio instruments.

In general, the paper speed, writing speed, and potentiometer should be chosen to optimize the response of the recorder and the accuracy and readability of the plotted data. An exception is the slow writing speeds, which reduce the speed of response or servo bandwidth, the recorder acting as a low-pass filter for variations in level. This function is used to filter out high-frequency fluctuations, taking an average of the true level response. However, it is possible to reduce the writing speed to the point where desired level variations are filtered out. Comparison with a preliminary recording taken with a fast writing speed will indicate this condition.

The following are some general recommendations:

- a. Choose the smallest-range potentiometer that will correspond to the dynamic range of the recorded signal. This will ensure maximum precision and accuracy.
- b. For most measurements, choose the fast (20 in./sec) writing speed. This ensures optimum response characteristics of the recorder. Slow speeds are for smoothing or filtering. (Refer to paragraph 4.8 for a discussion of error.)
- c. Choose a paper speed that will not crowd the recorded signal on the paper. In general, the faster the writing speed, the greater the paper speed must be to prevent crowding.

5.2 USE WITH SOUND-LEVEL METER. The recorder, when used with the Type 1551 Sound-Level Meter, is especially well suited for acoustic measurements. A complete discussion of measurements with the Sound-Level Meter may be found in the Operating Instructions for that instrument, in the HANDBOOK OF NOISE MEASUREMENT, published by General Radio, and in several *General Radio Experimenter* articles, including "Improved Performance plus a New Look for the Sound-Level Meter" by E. E. Gross, in the October, 1958, issue.

An adaptor-cable assembly supplied with the recorder can be used to connect the OUT jack of the Type 1551 to the recorder INPUT terminals. The recorder can be calibrated to indicate sound level in decibels above the standard reference level (0.0002 μ bar at 1000 cps) as follows:

- a. Turn both instruments on, with the recorder connected to the Sound-Level Meter as described above.
- b. Set the Type 1551 attenuator switch to 130 CAL.
- c. Set the Type 1551 WEIGHTING switch to CAL. and adjust the CAL control for a 10-db meter indication. A fixed-level 1-kc signal is now being fed into the recorder.
- d. Adjust the recorder INPUT ATTENUATION and CAL controls to bring the pen to full scale with the 20- and 40-db potentiometers (to 20 db below full scale with the 80-db potentiometer). The chart paper now corresponds to the meter scale, with full scale on the meter (10 db) representing full scale (20 db below full scale with the 80-db potentiometer) on the chart paper.
- e. Readjust the Type 1551 CAL thumbset control until the meter reads within the white CAL area.

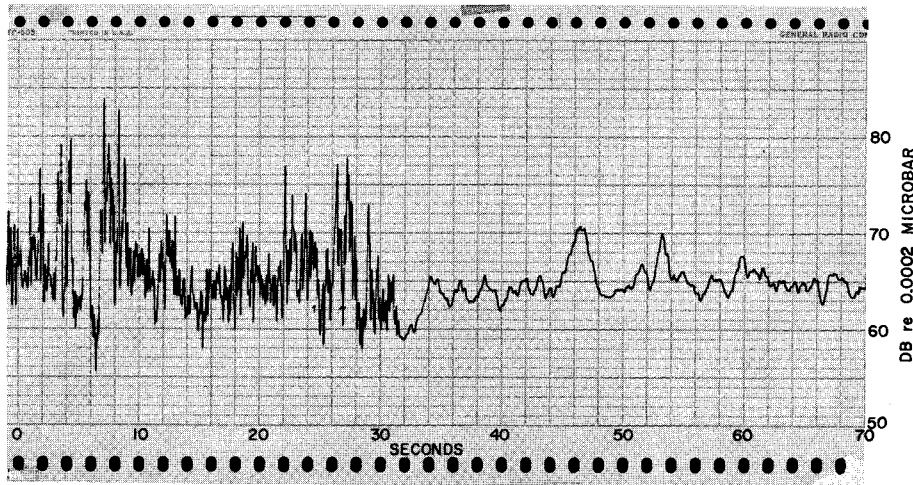

Figure 5.1. Recording of noise level in a cafeteria with both fast and slow writing speeds and 40-db potentiometer.

The Sound-Level Meter may now be operated in the normal manner, with full scale on the chart paper calibrated to represent 10 db plus the reading on the Type 1551 attenuator. The slower writing speeds can be used to provide a recording of averaged sound level (see Figure 5.1).

Ordinarily the recording will not be limited by the characteristics of the Sound-Level Meter. With the 80-db potentiometer, however, the maximum recordable level will be about 10 db below full scale on the paper. The residual noise from the Sound-Level Meter will appear near the bottom of the recorder scale for attenuator switch settings of 70 db and higher on the Sound-Level Meter. Refer to the HANDBOOK OF NOISE MEASUREMENT, published by General Radio Company, for a discussion of errors and corrections when the recorded level is near this residual noise level.

5.3 HIGH-LEVEL SOUNDS (above 80 db). For the measurement of high-level sounds, the Type 759-P25 Dynamic Microphone Assembly and Type 1551-P1 Condenser

Microphone Assembly have high enough outputs to work directly into the recorder. Table 5.1 shows the range of sound levels that can be made either with the Sound-Level Meter or with a microphone connected directly to the recorder. At very high sound levels, the input impedance of the recorder must be increased to avoid loading down the cathode follower in the microphone preamplifier. The value of the series resistor that should be used between the microphone and the recorder is given in Table 5.1.

The equipment should be calibrated by means of the Type 1552-B Sound-Level Calibrator and a suitable oscillator source, such as the Type 1307-A Transistor Oscillator.

5.4 VIBRATION LEVEL VS TIME. Vibration level vs time can be recorded with the output of the vibration measuring system (Type 761-A Vibration Meter or an array consisting of Type 759-P35 Vibration Pickup, Type 759-P36 Control Box, and Type 1551 Sound-Level Meter) connected to the recorder INPUT terminals. The

TABLE 5.1
RANGE OF SOUND LEVELS WITH SOUND-LEVEL METER OR DIRECT MICROPHONE CONNECTION.

<i>Microphone</i>	<i>Dynamic Range of Sound Levels</i>	<i>Series Resistor (see Figure 5.2)</i>
Type 1551-B Sound-Level Meter	30 - 150 db	0
Type 1551-P1L Condenser Microphone	80 - 130 95 - 150	Requires cathode follower between microphone and recorder.
Type 1551-P1H Condenser Microphone	95 - 145 110 - 170	Requires cathode follower between microphone and recorder.

system using the Sound-Level Meter has a low-frequency limit of 20 cps. Measurements can be made down to 2 cps with the Type 761-A Vibration Meter, but can only be recorded down to 4.5 cps.

To make full scale on the chart paper correspond to full scale on the Type 761-A Vibration Meter, proceed as follows:

- a. Connect the output of the Vibration Meter to the recorder INPUT terminals.
- b. On the Vibration Meter, set the METER SCALE switch to CAL and push the METER READS CAL 1 button. Adjust the CAL screw-driver control so that the meter indicates 50 on the upper scale.
- c. Set the recorder pen to 6 db below full scale by means of the recorder INPUT ATTENUATION and CAL controls. Once set, these controls should not be readjusted.
- d. Calibrate the Vibration Meter as outlined on the cover of the instrument.

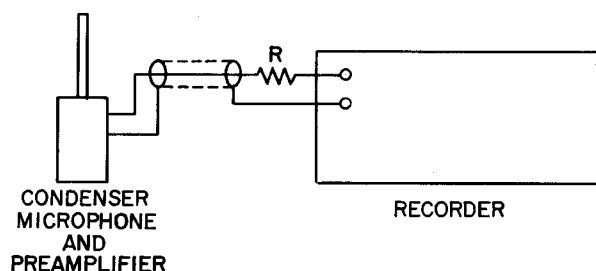

Figure 5.2. Direct connection of microphone to recorder.

Full scale on the Type 761-A meter now corresponds to full scale on the Type 1521-9428 Chart Paper. Figure 5.3 shows the conversion of the chart paper from db to the linear meter scale.

Set the maximum vibration level near full scale by means of the controls on the Vibration Meter; do not readjust the recorder controls.

The Type 1551 Sound-Level Meter, used in conjunction with the Type 759-P35 Vibration Pickup and Type 759-P36 Control Box, comprises an inexpensive vibration-measuring system, especially suited for use with the recorder. When ordering the Type 759-P35 and -P36 to complement an existing Type 1551 be sure to state the microphone sensitivity of the Sound-Level Meter (marked inside the case). The vibration attachments will then be factory-calibrated to this sensitivity.

Operation is as follows: first calibrate the chart paper to the Sound-Level Meter as described in paragraph 5.2. Set up the vibration-measuring equipment as

described in its instruction manual. The attenuator switch on the Sound-Level Meter should be set so that the maximum meter reading is almost full scale, to ensure maximum signal-to-noise ratio. The recorder readings can be converted to acceleration, velocity, or displacement by means of conversion factors marked on the control box and by the use of charts supplied with the control box.

5.5 REVERBERATION TIME AND DECAY RATE. A common method of determining the acoustic properties of a room is to fill the room with sound, suddenly silence the source of the sound, and measure the rate of decay of the sound in the room. This rate of decay can be defined in two ways. The common term is reverberation time (T), the time taken for the sound to decay 60 db in sound pressure level. Recently, however, a more useful term, decay rate (D) has been suggested.¹ There are numerous reasons mentioned in the reference for the preference of decay rate. One of the most important is that the decay in sound level can be described more completely, differentiating initial decay rate from average decay rate.

¹Robert W. Young, "Sabine Reverberation Equation and Sound Power Calculations", *JOURNAL OF THE ACOUSTICAL SOCIETY OF AMERICA*, Vol 31, No. 7, July 1959.

RESPONSE IN DB	TYPE 761-A METER READING	31.6	100	← FULL SCALE ON METER
		25.1	79.4	
		20.0	63.1	← EQUIVALENT TO HALF SCALE ON TYPE 761-A METER
		15.9	50.1	
		12.6	39.8	
		10.0	31.6	
		7.94	25.1	
		6.31	20.0	
		5.01	15.9	
		3.98	12.6	
		3.16	10.0	
		2.51	7.94	
		2.00	6.31	
1.59	5.01			
1.26	3.98			
1.00	3.16			
0	0.794	2.51		
	0.631	2.00		
	0.501	1.59		
	0.398	1.26		
	0.316	1.00		

Figure 5.3. Conversion of chart paper from db to rms values of velocity, acceleration, and amplitude.

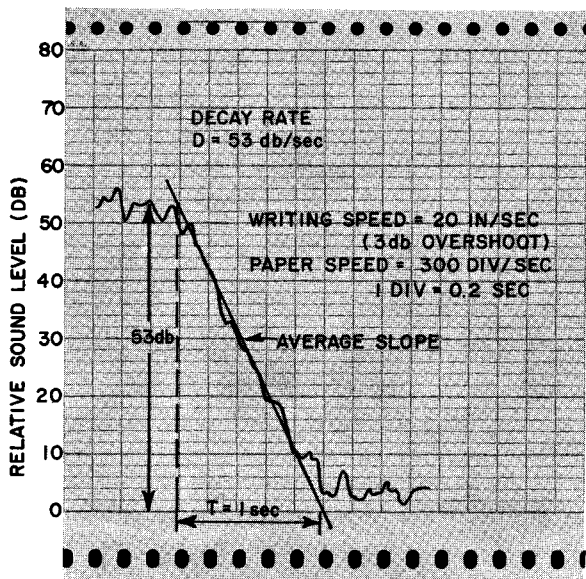

Figure 5.4. Decay rate for 1/3-octave band of noise at 500 cps.

The decay rate of sound pressure level, in decibels per second, can easily be converted to reverberation time by the following formula:

$$T = 60/D \text{ where } T = \text{reverberation time (seconds) and } D = \text{decay rate (db/sec)}$$

The Type 1521-A Graphic Level Recorder is a most convenient means of making this measurement, giving a permanent record of the sound decay (Figure

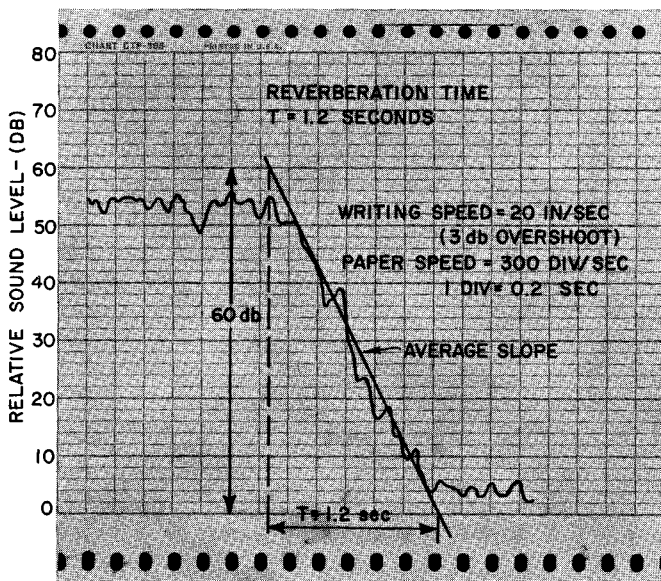

Figure 5.5. Reverberation time for 1/3-octave band of noise at 500 cps.

5.4) or reverberation time (Figure 5.5). The Type 1521-B will record decay rates as fast as 200 db per second (reverberation time of 0.3 second). When it is necessary to observe the beats during the sound decay, the decay rate should be limited to 120 db per second. (Refer to paragraph 4.8 for discussion of maximum decay rates.) When the Type 1521-B is used with a multiple-speed tape recorder, much faster decay rates can be recorded (as described later in this section).

Many sound sources are commonly used for reverberation measurements. One of the best is a band of random noise. The measurement is simple and offers results more repeatable than those produced by other types of sources.¹ (For a complete discussion of reverberation time, including a comparison of various methods, refer to Beranek's *ACOUSTIC MEASUREMENTS*, 1949, John Wiley and Sons, p. 806.)

Figure 5.6 shows the setup for reverberation measurements using a random-noise generator whose spectrum is flat with frequency. A third-octave-band filter following the generator is tuned to the desired frequency of measurement, generally 125, 250, 500, 1000, 2000, or 4000 cps. A switch after the filter permits instant silencing of the source. A power amplifier raises the level at least 40 db above the ambient noise level of the room or chamber. The type of loudspeaker is not critical, but its frequency response should be reasonably smooth, and it should not cause excessive distortion at the levels used. The preferred placement of the speaker is usually in a corner, where the maximum number of vibration modes are excited.

The microphone should be placed far away from the source to avoid excessive pickup of the incident sound wave. A microphone in a corner of the room is often ideal, since it will there pick up the maximum number of vibration modes. The Type 1551 Sound-Level Meter includes an excellent microphone and amplifier combination for this measurement. A third-octave or octave-band filter, tuned to the source frequency, used after the microphone amplifier will help to reduce background noise. If, for example, the ambient noise level in the room is 60 db, such a filter may reduce it to 40 db or even lower in the filter band. This means 20 db less output required of the loudspeaker. Only one filter is necessary if a tape recorder is used (described later in this paragraph).

To obtain the fastest writing speeds (in db/sec), use the 80-db potentiometer and set the DAMPING control for 3 to 4 db overshoot.

¹C.G. Balachandran, "Random Sound Field in Reverberation Chambers", *JOURNAL OF THE ACOUSTICAL SOCIETY OF AMERICA*, Vol 31, No. 10, October 1959.

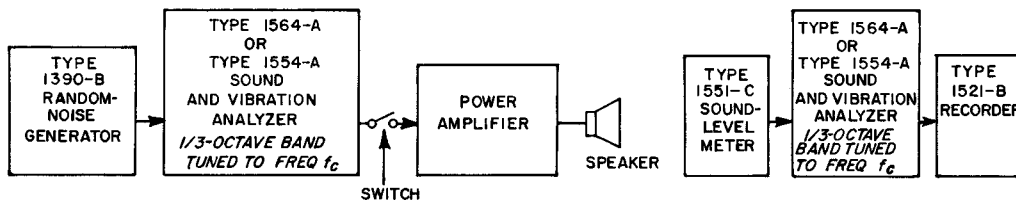

Figure 5.6. Setup for reverberation measurements.

After the random-noise source, recorder, and other equipment have been turned on, the measurement is performed as follows:

- a. Adjust the recorder pen, using the INPUT ATTENUATION and CAL controls, so that the ambient room noise is at the 0-db end of the chart for the 80-db potentiometer, just off scale for the 40-db potentiometer.
- b. Adjust the noise source for a 40- to 60-db level above ambient as indicated on the recorder paper.
- c. Turn on the recorder chart drive, set for maximum paper speed.
- d. Turn off the noise source, using the switch shown in Figure 5.6.

Read the decay rate from the chart in the following manner (see Figure 5.4):

- a. Average the slope with a straight line drawn on the chart paper.
- b. Find the decay in sound level for a convenient interval of time (1 sec, 0.5 sec, 0.2 sec).
- c. Extrapolate to find the decay in level for 1 second. This is the decay rate in db per second.

Read reverberation time from the chart in the following manner (see Figure 5.5):

- a. Average the slope with a straight line drawn on the chart paper. Extend the line from 0 to 60 db.
- b. Read the time interval for this 60-db change in sound level on the horizontal scale. For the fast paper speed (300 div/sec), one division equals 0.2 second.

For field use, sound decay can be recorded with a portable tape recorder, and later played back into the graphic level recorder. Only one 1/3-octave-band filter

is required for this type of measurement, since the source and output filters are used at different times. (See Figure 5.7 for the measurement setup.)

Pre-emphasis in the tape-recorder preamplifier requires keeping the recording level low above 1 kc, to avoid saturating the tape. Table 5.2 indicates the suggested recording level for various frequencies.

TABLE 5.2
TAPE-RECORDING LEVEL FOR REVERBERATION-TIME MEASUREMENTS

Frequency of Source	Recording Level (VU)
less than 1 kc	0
2 kc	-3
4 kc	-8
6 kc	-12
8 kc	-14

A multiple-speed recorder can be used to measure decay rates much faster than 200 db per second, if the decay is recorded at the fast tape speed and played back at a slower speed. The filter following the tape recorder should then be tuned to a fraction of the source frequency, f_0 , corresponding to the amount the speed was reduced. This also permits the observation of many irregularities occurring in the decay that might otherwise be filtered out by the recorder. Some two-channel tape recorders permit even greater portability, since the noise source can be prerecorded on one channel, obviating the presence of generator and filter at the scene of measurement.

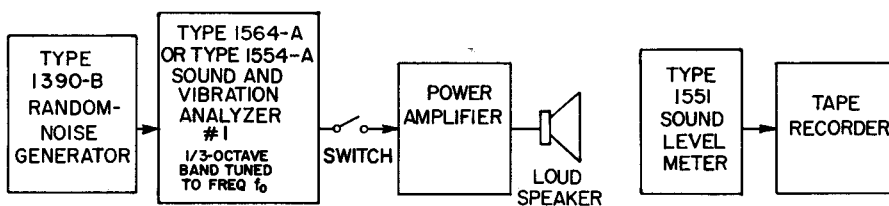
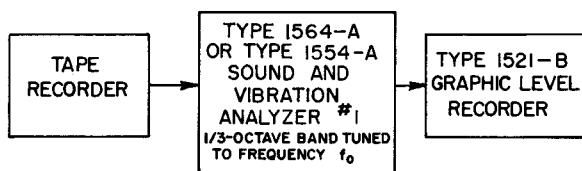

Figure 5.7. Setup for portable reverberation measurements.





5.6 VU RECORDINGS. By definition, the only accurate method of measuring VU of a complex waveform is with a VU meter. Any other device, such as a level recorder, should be recognized as providing only an approximation.

The ballistics of a VU meter and of a level recorder are different. If a sinusoidal voltage giving reference deflection is suddenly applied to a VU meter, the meter pointer will reach 99 percent of the reference deflection in 0.3 second.¹ The meter scale, however, is linear, so the speed in db per second is not constant. The level recorder, on the other hand, has a speed constant in db per second. If the level recorder is to approximate the results of a VU meter, therefore, its writing speed should be set to correspond to the VU meter in the region of the VU value to be measured (refer to Table 5.3). The preferred region for measurement on a VU meter is from -3 to +3 VU. To correspond in this region, the recorder writing speed should be set to 10 in./sec for the 20-db potentiometer, or 3 in./sec for the 40-db potentiometer.

TABLE 5.3

SPEED CHARACTERISTICS FOR VU MEASUREMENT

VU Meter Speed Characteristics 0.3 sec for 0 to 99% Deflection		Writing Speed	
Region - db scale	Velocity, db/sec	20-db pot.	40-db pot.
+2 to +3	22		
+1 to +2	24		
0 to +1	30		
-1 to 0	31	50 db/sec =	30 db/sec =
-2 to -1	34	10 in./sec	3 in./sec.
-3 to -2	39		
-5 to -3	46		100 db/sec =
-7 to -5	58		10 in./sec.
-10 to -7	77	100 db/sec =	200 db/sec =
-20 to -10	286	10 in./sec.	20 in./sec.

The choice of potentiometer will depend upon the dynamic range encountered. In this respect, a level recorder is more useful than a VU meter, since it will also record ambient noise level. Thus more than 20 db of dynamic range (the range of a VU meter) may be useful.

¹"IRE Standards on American Recommended Practice for Volume Measurements of Electrical Speech and Program Waves", 1953, PROCEEDINGS OF THE INSTITUTE OF RADIO ENGINEERS, Vol 42, No. 5, May 1954.

²"Improved Performance Plus a New Look for the Sound-Level Meter", E. E. Gross, GENERAL RADIO EXPERIMENTER, October 1958, pp. 4, 5.

³For complete details refer to "Automatic Measurement of Phonograph Reproducers", by B. B. Bauer, GENERAL RADIO EXPERIMENTER, January-February 1962, obtainable upon request.

The detectors used in the recorder and in the VU meter are fairly similar. That in the recorder is an rms detector, that in the VU meter an average-reading detector. The difference is 1 db for noise, square waves, and two-signal addition.²

5.7 FREQUENCY RESPONSE MEASUREMENTS USING TYPE 1304-B BEAT-FREQUENCY AUDIO GENERATOR.

The frequency response of transducers and electrical devices can be automatically plotted with the recorder and Type 1304-B Beat-Frequency Audio Generator (refer to paragraph 3.4.2). Figures 5.8 and 5.9 show examples.

5.8 FREQUENCY-RESPONSE MEASUREMENTS OF PHONOGRAPH REPRODUCERS.³

Automatic frequency-response measurements of stereophonic phonograph cartridges are made possible by use of the Type STR 100 Stereophonic Frequency Test Record produced by CBS Laboratories. This record has a frequency-swept band recorded from the output of a Type 1304-B Beat-Frequency Audio Generator driven by a Type 1521-A Graphic Level Recorder. The swept band is recorded first on one channel, then on the second channel. Thus a recorded frequency response of a given channel can be made. If the recorder remains connected to this channel, the second frequency swept band gives a measurement of the cross talk between the two channels versus the frequency.

5.9 CONSTANT SOUND-PRESSURE LEVEL. The servo system of the Type 1521-B Graphic Level Recorder can be used to control sound-pressure level or voltage to obtain flat frequency response. Such control is useful in a number of applications, including, for example, microphone calibration.

A convenient method of microphone calibration uses a source of sound level that is flat with frequency at the location of a microphone to be tested. This is difficult even with a very good loudspeaker and anechoic chamber. However, if two microphones are placed side-by-side in an anechoic chamber, the Type 1521-B Graphic Level Recorder will control the sound level to the reference microphone to within 1/4 db of the frequency response of this microphone. The dynamic range of the control is limited only by the potentiometer used, a 40-db potentiometer covering most applications. A condenser microphone should be used as the reference, since the degree of flatness of sound-pressure level with frequency is only as good as the microphone. The microphone under test is placed next to the reference microphone in an anechoic chamber, so that the sound-pressure level will be constant with frequency in the

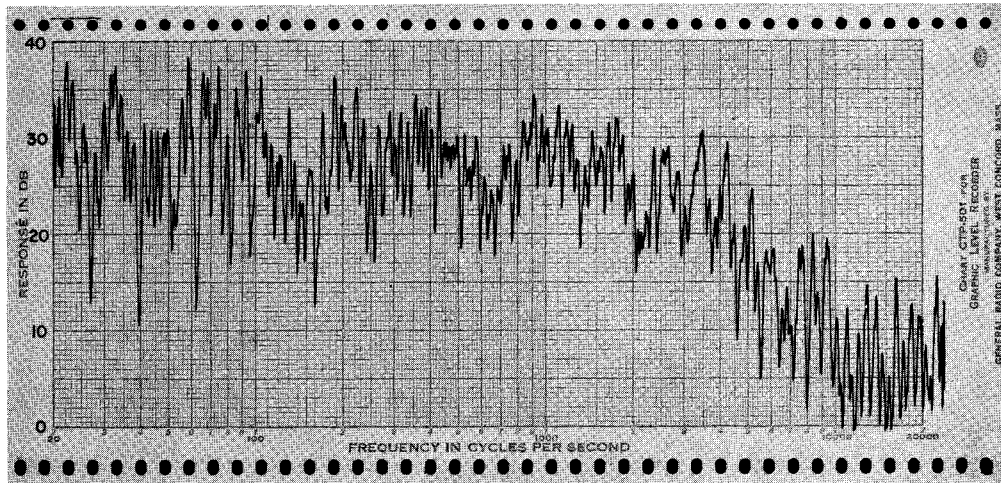

Figure 5.8. Recordings of the frequency response of a public-address system, taken with 20 in./sec (above) and 3 in./sec (below) writing speeds.

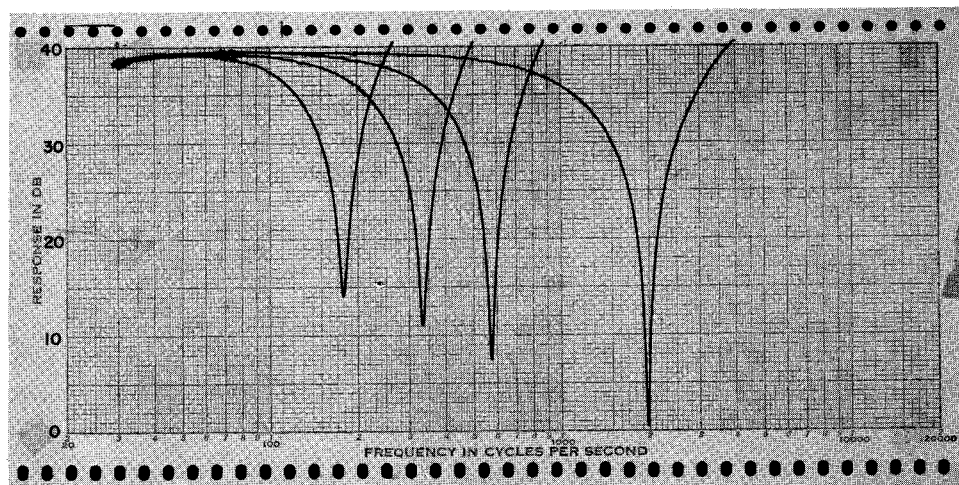
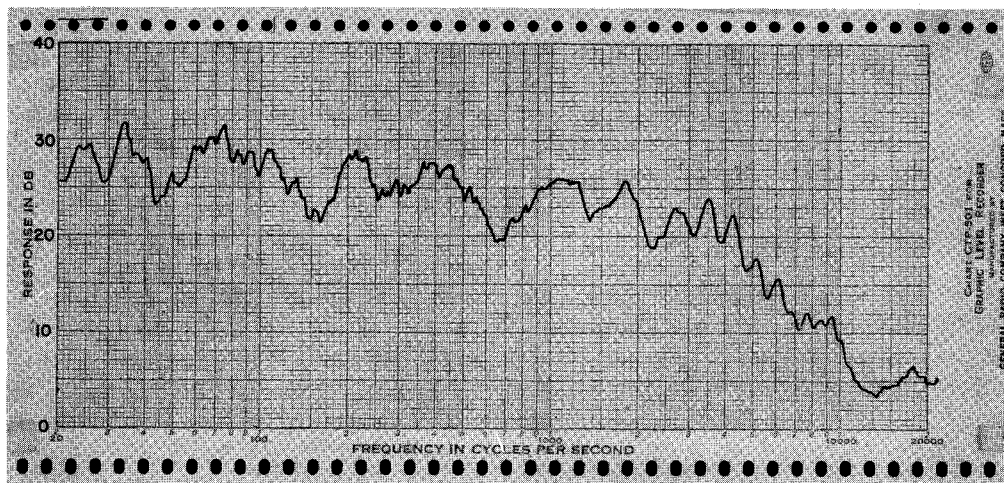

Figure 5.9. Recording of transmission characteristics of an adjustable notch filter for four different frequency settings.

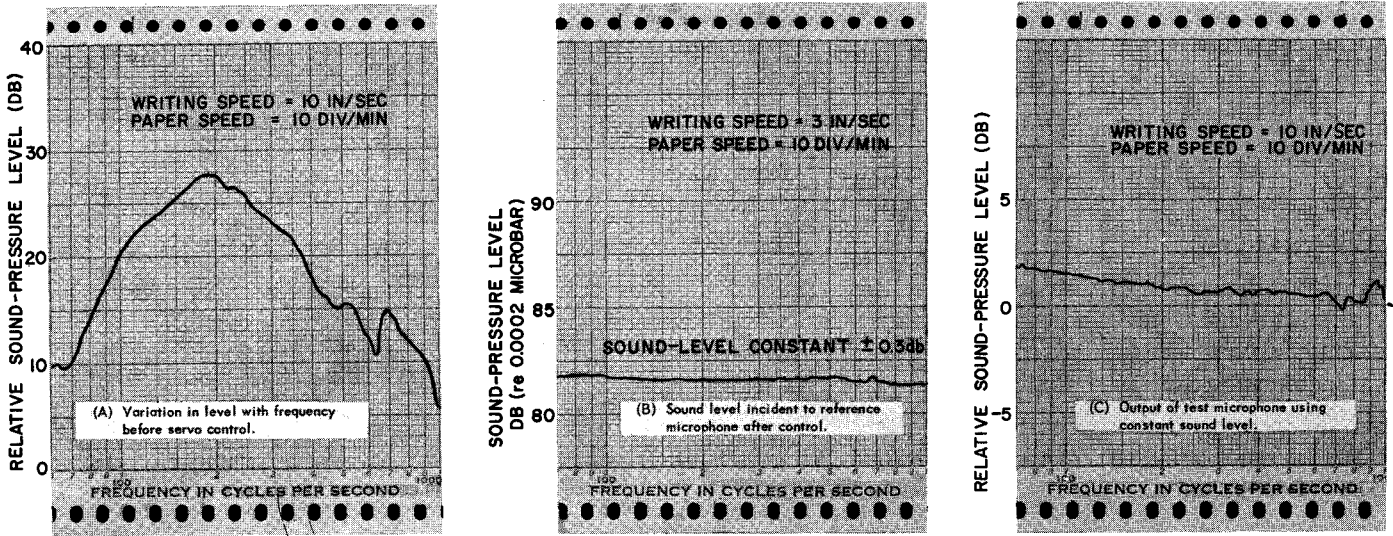

Figure 5.10. Use of recorder to control sound level for microphone calibration.

immediate vicinity of the reference microphone. The output of the test microphone is then recorded on a separate recorder as the frequency is swept, the resulting plot being the frequency response of the microphone. Figure 5.10 shows recordings of a microphone calibration made in the frequency range from 70 cps to 1 kc.

This method of microphone calibration is not perfect, however. At frequencies above 1 kc the second microphone placed near the reference microphone disturbs the sound field incident to the reference micro-

phone, and vice versa. A loudspeaker that is reasonably flat with frequency and a very small reference microphone will reduce this effect.

The setup for measurement is shown in Figure 5.11 and the equipment is described in Table 5.4. In order to appreciate how the recorder servo controls the sound-pressure level, reread paragraph 1.2. The recorder servo keeps the input to the ac amplifier at a constant level (1 mv when calibrated). When the level changes, the drive coil moves the potentiometer arm until the voltage is again at this level. If the servo loop is broken be-

TABLE 5.4
EQUIPMENT NEEDED TO PROVIDE CONSTANT SOUND-PRESSURE LEVEL

Equipment	Description
Type 1521-B Graphic Level Recorder	Recorder No. 1 in Figure 5.11, with 20- or 40-db potentiometer.
Type 1521-P10B Drive Unit	Couples Type 1304-B to Recorder chart drive.
Type 1521-P15 Link Unit	
Preamplifier and Power Amplifier	Provides 10 watts undistorted output power for 50 mv input. Hum and noise must be at least 60 db below full output. Example: Type 1233-A Power Amplifier, with preamplifier gain of 4. Output impedance should be matched to loudspeaker with transformer.
Loudspeaker	Produces low-distortion (below 3%) sound in frequency range of interest. Must handle maximum power from amplifier above.
Type 1551-P1L Condenser Microphone System	Reference microphone and preamplifier shown in Figure 5.11.
Attenuator	Input impedance at least 10 kilohms or more. Output impedance 1 kilohm or less. Resistors are 5%, 1/2-watt rating. The output resistor (1 k) should be connected directly between points 103 and 110 on the etched board, so that hum pickup will be low.
Type 1304-B Beat-Frequency Audio Generator	Signal source.

tween the potentiometer arm and the ac amplifier, and two transducers are inserted as shown in Figure 5.11, the servo system will still maintain the constant level into the ac amplifier. Thus the action is as follows:

The reference microphone converts sound-pressure level into a voltage, which must be attenuated to 1 millivolt at the desired sound-pressure level. This voltage is fed into the input of the ac amplifier on the recorder. If the microphone output is not at 1 millivolt (i.e., if the sound-pressure level is not constant), the servo repositions the potentiometer arm to change the input to the sound source, the loudspeaker. Previously the recorder servo held the input to the ac amplifier at a constant level; now the sound level incident to a reference microphone is held at a constant level. The resulting plot obtained during this control will be the frequency response of the source at the reference microphone.

The procedure for obtaining constant sound-pressure level is as follows:

- a. Disconnect the jumper between points 102 and 103 on the etched board.
- b. Connect the system as shown in Figure 5.11, using the equipment described in Table 5.4. Shielded leads should be used, except from the power-amplifier output to the loudspeaker.
- c. Adjust the oscillator output to about 50 mv. At higher voltages, capacitive coupling into the ac amplifier becomes intolerable.
- d. Turn Recorder No. 1 on. Increase the amplifier gain between point 102 and the loudspeaker until the pen moves upscale (away from 0 db). A fast writing speed should be used (10 or 20 in. sec) with a slow paper speed (10 div/min).
- e. Adjust the attenuator after the microphone preamplifier or the CAL control on Recorder No. 1 until the desired sound-pressure level is obtained. An attenuation of 20 db after the Type 1551-P1L Condenser Microphone System will give a sound level of about 100 db.

f. Sweep the oscillator through the desired frequency range, adjusting the gain of the amplifier between point 102 and the loudspeaker or the oscillator level, if necessary, to keep the pen on the paper. Control is obtained only when the pen is free to move.

5.10 DIRECT COMPARISON OF LEVELS. The recorder can plot the ratio in db of two signal voltages, provided that the one used as the reference is constant within 9 db. (Refer to paragraph 5.9 for level changes greater than 9 db.) The action is as follows:

One of the signal voltages to be compared is rectified and used as the reference voltage in the recorder. The other signal voltage is applied to the input of the recorder. The recorder will then plot the ratio of the two signals, since one signal is compared with the reference voltage (the other signal, rectified). The accuracy of this plot will depend on the variation in the reference voltage. The extent of the correction for variation in the reference voltage can be seen from Table 5.5.

TABLE 5.5
SOURCE-LEVEL VARIATIONS

Total Variation of Source Level (db)	Corresponding Variation of Recorder Pen (db)
18 (max)*	0.4
15*	0.2
10	0.1

* D105 and D106 disconnected from Circuit.

One example of this comparison is the frequency response measurement of a loudspeaker where the output of the Type 1304-B Beat-Frequency Audio Generator is fed through a power amplifier to the loudspeaker. If the frequency response of the power amplifier is not flat, correction can be made by use of the power-amplifier

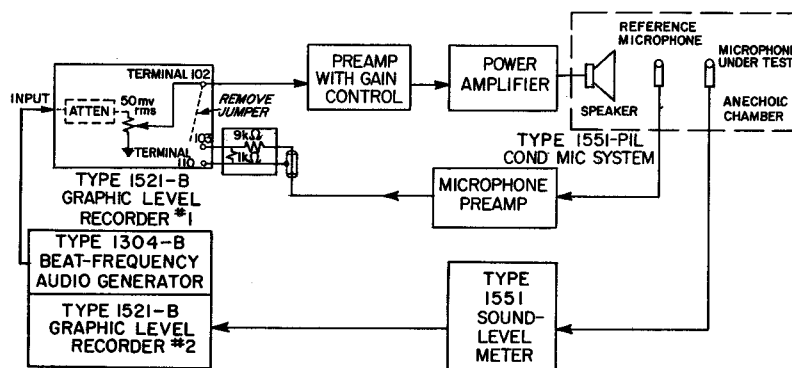

Figure 5.11. Setup for microphone calibration.



output as the voltage fed into the detector circuit (see Figure 5.12). Note that this will not correct variations greater than 18 db.

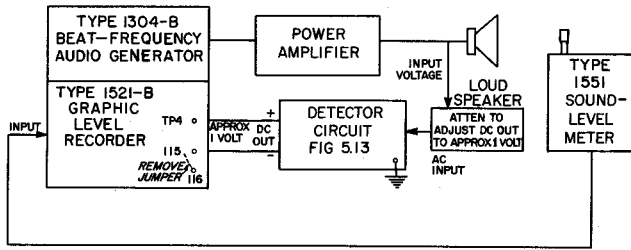

Figure 5.12. System used to measure ratio of output to input as a function of frequency.

The detector circuit used to convert the ac signal into the dc reference voltage is shown in Figure 5.13.

a. Remove the jumper between terminals 115 and 116 on the etched board. Connect the negative side of the detector circuit to terminal 115 and the positive side to TP4 on the etched board (see Figure 5.12).

b. Connect the rest of the circuit as shown in Figure 5.12, with one exception: the input to the detector circuit is also used as the input to the recorder.

c. Adjust the sound level of the loudspeaker as desired by setting the oscillator or power-amplifier gain control.

d. With a dc voltmeter between terminal 115 and TP4 (see Figure 5.12 for polarity), adjust the attenuator until the indicated dc voltage is about 1 volt.

e. Turn the recorder OVERSHOOT control fully counterclockwise and turn the CREEP control fully clockwise (see Figure 2.2). For maximum correction range (greater than 10 db), unsolder diodes CR105 and CR106 from the etched board at terminals 113 and 114. (Otherwise a range greater than 10 db would result in a low-frequency response depending on the dc reference level.)

f. Turn on the recorder and position the pen on scale by means of the INPUT ATTENUATION control.

g. Vary the attenuator between the loudspeaker and the input to the detector circuit (See Figure 5.12) over a range where the pen does not move significantly. Set the detector input level at midpoint to ensure the maximum correction range.

h. Disconnect the cable going to the recorder input and connect the circuit as shown in Figure 5.12.

The frequency response of the system is now plotted, as the recorder indicates the ratio of sound level to speaker input voltage.

5.11 FREQUENCY ANALYSIS. Frequency analysis of sound, vibration, noise, and other complex waveforms can be made with the Type 760-B Sound Analyzer, or the Type 1564-A or 1554-A Sound and Vibration Analyzer. In the measurements described in paragraphs 5.2, 5.3, and 5.4, the analyzer can be placed between the Type 1551 Sound-Level Meter or Type 761-A Vibration Meter and the recorder, thus analyzing the sound, vibration, or noise.

To set the 0-db level, the complete frequency range should first be passed through the analyzer into the recorder. On the Type 1564-A or 1554-A, set the BANDWIDTH switch to ALL-PASS; on the Type 760-B release all the frequency buttons. Set the analyzer gain so that the meter reads upscale (for maximum signal-to-noise ratio). The recorder can then be set to some arbitrary 0-db reference by means of the INPUT ATTENUATION and CAL controls.

Before proceeding with the analysis, give careful consideration to the choice of weighting used on the Sound-Level Meter, which is discussed in the operating instructions for the Sound-Level Meter and, more fully, in the HANDBOOK OF NOISE MEASUREMENT, available from General Radio Company.

In the analysis, the maximum recorded level will be a little lower than the total level in the all-pass band. It may be desirable to use this maximum level as an arbitrary reference. The recorder pen can be set to this reference level by means of the INPUT ATTENUATION and CAL controls.

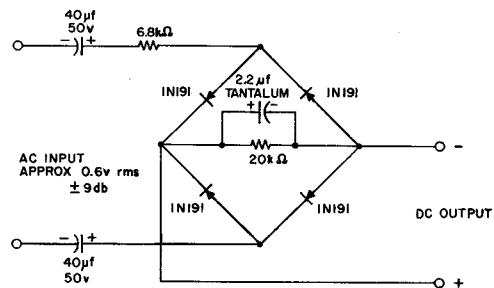

Figure 5.13. Detector circuit diagram.

SECTION 6

SERVICE AND MAINTENANCE

6.1 GENERAL.

6.1.1 WARRANTY. We warrant that each new instrument manufactured and sold by us is free from defects in material and workmanship and that, properly used, it will perform in full accordance with applicable specifications for a period of two years after original shipment. Any instrument or component that is found within the two-year period not to meet these standards after examination by our factory, District Office, or authorized repair agency personnel will be repaired or, at our option, replaced without charge, except for tubes or batteries that have given normal service.

6.1.2 SERVICE. The two-year warranty attests the quality of materials and workmanship in our products. When difficulties do occur, our service engineers will assist in any way possible. If the difficulty cannot be eliminated by use of the following service instructions please write or phone our Service Department (see back of manual), giving full information of the trouble and of steps taken to remedy it. Be sure to mention the serial, type and ID numbers of the instrument.

Before returning an instrument to General Radio for service, please write to our Service Department or nearest District Office, requesting a "Returned Material Tag." Use of this tag will ensure proper handling and identification. For instruments not covered by the warranty, a purchase order should be forwarded to avoid unnecessary delay.

6.2 CLEANING AND LUBRICATION.

6.2.1 MOTOR. The lubrication port on the top of the motor is sealed by a small screw. Remove this screw and apply 20 drops of oil every three months. Standard SAE 20 motor oil is a satisfactory lubricant.

6.2.2 GEAR BOX. The gear box should not be lubricated, or it will collect dirt and cause noisy operation.

Self-lubricating bearings are used with moving parts throughout the recorder.

6.2.3 GUIDE ROD. The guide rod on which the coil assembly rides should be cleaned with a clean soft dry cloth, to ensure maximum writing-speed capability. Under no condition should it be oiled.

6.2.4 POTENTIOMETER. If operation of pen with constant-level input becomes noisy, the potentiometer needs cleaning. Use a clean, lint-free cloth.

6.2.5 PEN. When not in use, the cap provided with the pen should be used to cover the point. If left uncovered for up to two days, the pen will write satisfactorily if it is moved slowly on the chart paper until ink flows. If the recorder is used daily, no capping of the point is necessary.

6.3 OVERSHOOT AND CREEP ADJUSTMENTS.

6.3.1 GENERAL. The overshoot and creep controls are set at the factory and normally should not require adjustment, except possibly when an 80-db potentiometer is used or when the DAMPING control setting is changed appreciably.

6.3.2 OVERSHOOT ADJUSTMENT. With the 40-db potentiometer installed, and with the writing speed set at 20 in./sec, proceed as follows:

a. Apply a constant-level input to the recorder INPUT terminals, and set the pen near the top of the scale.

b. Using either the recorder's INPUT ATTENUATION control or preferably, an external attenuator, quickly decrease the level 20 db, and observe the amount of overshoot.

c. Adjust the DAMPING control for the amount of overshoot desired (1 division, 1 db on the 40-db potentiometer, is recommended).

TABLE 6.1
TROUBLE-SHOOTING CHART

<i>Symptom</i>	<i>Remedy</i>
Low gain, ac amplifier. Unable to get max sensitivity of 1 mv. Erratic operation of pen with constant-level input signal. Unsymmetrical waveform and overshoot.	Substitute higher- h_{fe} transistor in ac amplifier (Q102, Q105). Clean potentiometer. (Refer to paragraph 6.2.4.) First adjust for symmetrical overshoot (refer to paragraph 6.3). If this does not solve the problem, transistor pairs Q110, Q111 and Q112, Q113 may not be matched in current gain, h_{fe} . (Refer to Parts List for replacement.)
Oscillation of pen.	Increase DAMPING (clockwise). Check resistance of feedback coil. (Refer to Table 6.2) Check to see that wires for drive coil and feedback coil are connected properly.
Poor static accuracy. Large region where servo will not balance.	Check current gain of transistors in dc amplifier. Replace transistors if necessary. (Refer to Parts List.)
No force on drive coil.	Check resistance of drive coil (refer to Table 6.2). Check transistors in dc amplifier. Replace, if necessary (refer to Parts List).

- d. Turn the CREEP control fully clockwise.
 - e. Using an attenuator as in step b, quickly increase the level 20 db, and observe the amount of overshoot.
 - f. Adjust the OVERSHOOT control so that the overshoot observed in step e equals that achieved in step c.
- The above procedure may be followed with an 80-db potentiometer used in place of the 40-db unit. For 20-db potentiometers, first make the adjustments in paragraphs 6.3.2 and 6.3.3, using a 40-db potentiometer, and then adjust the DAMPING control for the desired overshoot (1/2 db recommended) with the 20-db potentiometer.

- 6.3.3 CREEP ADJUSTMENT.** With the 40-db potentiometer installed, and with the writing speed set at 10 in./sec, proceed as follows:
- a. Apply a constant-level input to the recorder INPUT terminals, and set the pen near the bottom of the scale.
 - b. Using either the recorder's INPUT ATTENUATION control or, preferably, an external attenuator, quickly increase the level 20 db, and observe the amount of creep. Creep is the slow return of the pen to its steady-state value after overshoot or undershoot. Adjust the CREEP control to remove creep.

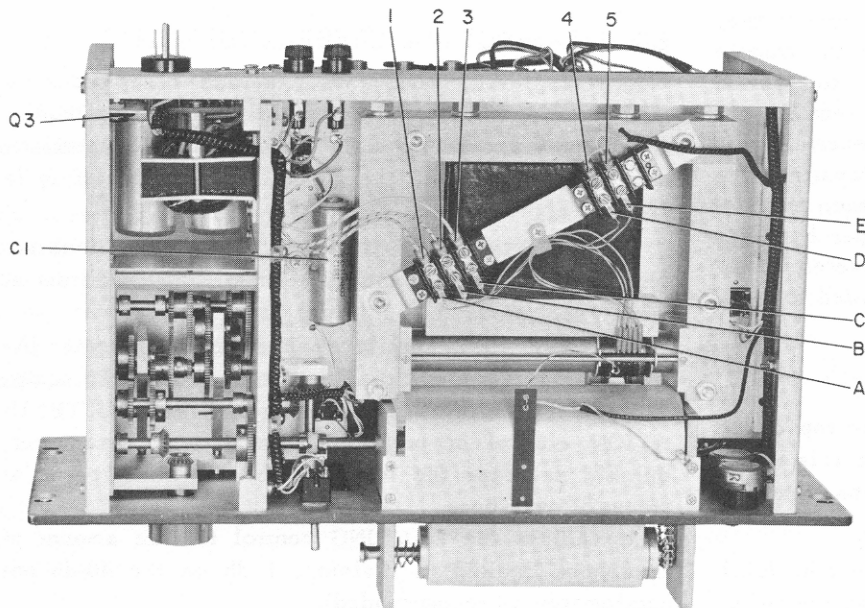

Figure 6.1. Bottom view.

c. As a final check on overshoot and creep, set the writing speed to 20 in./sec, and switch in 20-db attenuation steps, observing that the overshoot is symmetrical for increases and decreases in both directions, and that the pen quickly returns to its steady-state value.

6.4 TROUBLE-SHOOTING PROCEDURE. The following equipment is required:

- | | |
|-----------------------------|----------------------|
| Voltmeter, 20,000 ohms/volt | Oscilloscope |
| Ohmmeter | Sine-wave oscillator |

If the recorder is inoperative, the most straightforward way of locating the trouble is to apply a known signal to the INPUT terminals and trace it through to the coil-and-pen assembly. The procedure is as follows:

a. Apply a 1-volt, 1-kc signal to the INPUT terminals of the recorder.

b. With a 40-db potentiometer installed, set the INPUT ATTENUATION control to 40 db. The pen should position itself at midscale. If it does not, proceed to step c.

c. The normal input to the ac amplifier is 1 mv (refer to paragraph 1.2). To apply 1 mv to the ac amplifier, with 1 volt at the INPUT terminals, set the INPUT ATTENUATION switch to 60 db. Then move the pen to 0 db (as marked on the potentiometer).

d. Connect a dc voltmeter (20,000 ohms/volt) to the output of the detector, as follows: Connect the positive voltmeter lead to TP4 and the negative lead to terminal 114. The voltmeter should indicate 1 volt. If not, check the output of the ac amplifier by connecting an oscilloscope to TP1 on the etched board. The signal at

TP1 should be 0.5 volt peak-to-peak, and of the same frequency as the input signal. If the frequency is 60 cps, check the grounding of the low INPUT terminal to the chassis, and make sure that the chassis is connected to a suitable external ground (refer to paragraph 2.1.7). If there is no signal present, check the collectors of the preceding transistor stages to isolate the faulty transistor.

e. If 1 volt is present at the detector output and the pen still does not respond, one of the transistors in the dc amplifier may be at fault. Check the voltages in the dc amplifier against those given in Table 6.2. The transistors in the dc amplifier are matched for dc characteristics, and some selection may be required to find an acceptable substitute. With a satisfactory replacement, the pen will not move as the WRITING SPEED control is switched from 3 to 1 in./sec.

The following tables lists other common troubles and their remedies. (Refer to Figure 6.8).

6.5 OTHER SERVICE PROBLEMS. The following service problems should be referred to the factory:

- (1) Replacement of parts on magnetic assembly (see Figure 4.1), including potentiometer contact and drive-coil assembly (except pen holder).
- (2) Other mechanical problems in the gear box or drum and chart-drive mechanism.
- (3) Electronic problems other than those listed in the trouble-shooting section.

**TABLE 6.2
DC VOLTAGE AND RESISTANCE CHART**

Transistor	Volts DC at Emitter*	Test Points	Volts DC**	Points (Fig. 6.1)	Ohms***
Q101	9	AT109	18	A-B	40
Q192	0.5	AT111	30	B-C	40
Q103	2.6	AT127	13	D-E	250
Q104	1.6	TP4	17		Measure voltage with 20,000 ohm/volt meter, to ground unless otherwise indicated. * Transistor mounting orientation on etched board: solder dot near collector E B •C ** Voltages with pen at rest and Q volt at detector output. *** First unscrew and remove wires 1 through 5, Figure 6.1.
Q105	5	TP4-AT113	0.7		
Q106	1.4	TP4-AT114	1.0		
Q107	1.4	TP4-AT116	1.0		
Q108	16	col. Q1	13 †		
Q109	16	col. Q2	13 †		
Q110	16				
Q111	16				
Q112	23				
Q113	23				

† See Figure 2.2 for location of Q₁ and Q₂, and Figure 6.1 for location of Q₃.



TABLE 6.3
TEST EQUIPMENT

<i>Equipment Type</i>	<i>Minimum Requirements</i>	<i>Recommended Model</i>
Oscillator	Frequency: 1 kHz to 200 kHz Voltage: 10 V into 600 Ω	GR 1310 Oscillator
Decade attenuator	Range: 80 dB, in 0.1-dB steps	GR 1450 Decade Attenuator
DC voltage source	Range: 0 V to 1 V (dc), variable	Kepeco (any ABC model)
AC/DC voltmeter with ac probe	Range: 0 V to 1 V (ac and dc) Accuracy: $\pm 3\%$ ac; $\pm 2\%$ dc	GR 1806 Electronic Voltmeter
Patch Cords	Double plug Single plug	GR 274-NP GR 274-LL
Load Resistor	600 $\Omega \pm 1\%$	GR 500-G

6.6 MINIMUM PERFORMANCE STANDARDS. The following procedure for checking the Type 1521 specifications is recommended for incoming inspection or periodic operational testing.

6.6.1 EQUIPMENT REQUIRED. Table 6.3 lists minimum requirements for the test equipment recommended for test purposes. Equivalent equipment may be substituted for the models recommended.

6.6.2 TEST PROCEDURES.

FREQUENCY RESPONSE. To check the frequency response (level recording), proceed as follows:

- Connect the output of the oscillator (GR 1310) to the input terminals on the Type 1521 recorder.
- On the recorder: set the CALIBRATE control to its maximum cw position, set the WRITING SPEED control to 3 IN/SEC, and switch the INPUT ATTENUATION control to 40 dB.
- On the oscillator: set the frequency to 1 kHz and the output level so that the recorder pen is positioned at mid-scale on the chart, thus establishing a reference level for the frequency-response tests.
- Observe the high-frequency response: ± 2 dB with the oscillator frequency set at 200 kHz.
- Observe the low-frequency response as indicated in Table 6.4. As described in the specifications, the low-frequency response depends on writing speed.

POTENTIOMETER LINEARITY. To check the linearity of the 20-dB, 40-dB, and 80-dB potentiometers, proceed as follows:

- Set up the test circuit shown in Figure 6.2. The 600- Ω load resistor is connected across the output terminals of the decade attenuator and the voltmeter (via its probe) is connected to monitor the output of the oscillator. Two patch cords, GR 274-NP, can be

TABLE 6.4

LOW-FREQUENCY RESPONSE

<i>Writing Speed (0.1-in. overshoot)</i>	<i>Frequency (cutoff) Hz</i>	<i>Response (down) dB</i>
20	100	<1
10	20	<1
3	7 4.5	<1 3
1	7 4.5	<1 3

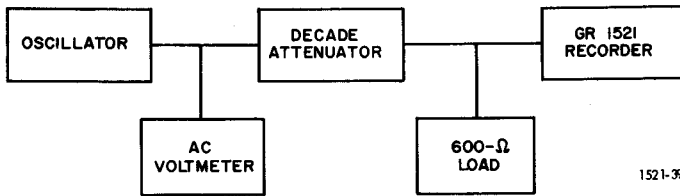

Figure 6.2 Test circuit for checking ac potentiometers used in the 1521.

used to connect the oscillator and recorder to the decade attenuator.

b. On the recorder: set the INPUT ATTENUATION control to 10 dB, WRITING SPEED to 3 IN/SEC, and CHART DRIVE to OFF.

c. On the oscillator: set the frequency to 1 kHz and the output level to 1 V as indicated on the voltmeter.

d. On the decade attenuator: set the attenuation to position the recorder pen on the left-hand (maximum dB) border of the chart paper. This setting establishes a reference for changes in attenuator settings called for

in Table 6.5. The reference setting must be reset for each potentiometer.

e. Increase the decade-attenuator setting, in steps, as indicated in Table 6.5 and observe the position of the pen at each step; the pen should be at its correct position on the chart within the limits given in the table.

f. Reset the oscillator to 100 kHz and repeat the above procedure.

g. Reset the oscillator to 200 kHz and repeat the procedure.

To check the linearity of the linear (dc) potentiometer (P/N 1521-9604), proceed as follows:

a. Set up the test circuit shown in Figure 6.3. In this circuit, the voltmeter is connected to monitor the output of the dc voltage source. Two single-plug patch cords, GR 274-LL, can be used to connect the dc source to the recorder.

b. On the recorder: set the INPUT ATTENUATION control to 0 dB, WRITING SPEED to 3 IN/SEC, and CHART DRIVE to OFF. Plug the potentiometer cable into the D-C POT connector (see 10, Figure 2.2).

c. Set the output of the dc voltage source to either 0.8 V or 1 V, as indicated by the voltmeter.

TABLE 6.5

POTENTIOMETER LINEARITY
(20 dB, 40 dB, and 80 dB)

Potentiometer	Attenuation* (Decade Attenuator)	Linearity Specifications		
		1 kHz	100 kHz	200 kHz
20 dB	Increase in 2-dB steps (4 divisions on the chart) from reference setting.	±0.2 dB	±0.7 dB	±1.7 dB
40 dB	Increase in 4-dB steps (4 divisions on the chart) from reference setting.	±0.4 dB	±0.9 dB	±1.9 dB
80 dB	Increase in 8-dB steps (4 divisions on the chart) from reference setting.	±0.8 dB	±1.3 dB	±2.3 dB

*The attenuation, in terms of chart-paper divisions, is based on a chart with 40 vertical divisions, such as the one (P/N 1521-9428) originally supplied.

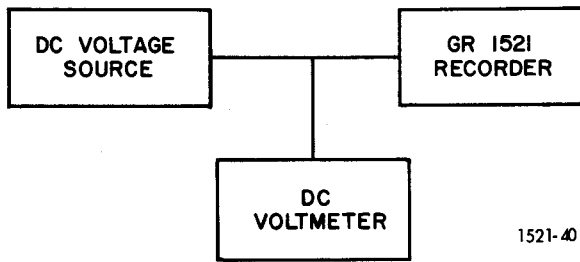

1521-40

Figure 6.3. Test circuit for checking the linear (dc) potentiometer used in the 1521.

NOTE

The full-scale sensitivity of the linear (dc) potentiometer is normally set to 0.8 V for use with 40-division paper. For 50-division chart paper, however, the full-scale sensitivity is adjusted to 1-V full scale by means of the thumb-set adjustment on top of the potentiometer.

d. Set the pen on the right-hand (full-scale) border of the chart paper, using the thumb-set adjustment on the top of the potentiometer (see NOTE above).

e. Reduce the dc input to 0.5 V. Use the thumb-set adjustment on the front of the potentiometer to position the pen at the exact 0.5-V division on the chart.

f. Vary the dc input to position the pen at major divisions on the chart paper (0.2 V, 0.4 V, and 0.6 V are recommended for minimum check) and observe the position of the pen at each setting; it should be within $\pm 1\%$ of full scale (± 0.01 V or ± 0.008 V, depending on full-scale value).

MAXIMUM SENSITIVITY. To check the maximum sensitivity, using any of the ac potentiometers for level recording, proceed as follows:

a. Set up the test circuit shown in Figure 6.2.

b. On the recorder: set the INPUT ATTENUATION control to 0 dB, WRITING SPEED to 3 IN/SEC, CHART DRIVE to OFF, and the CALIBRATE control fully ccw.

c. On the decade attenuator: set to 60 dB.

d. On the oscillator: set the frequency to 1 kHz and the output level to 1 V as indicated on the voltmeter. The pen should position itself to the left of 0 (1mV, at the right-hand border on the chart).

To check maximum sensitivity, using the dc potentiometer, follow the previous instructions for checking the linearity of the dc potentiometer, steps a through d.

6.7 KNOB REMOVAL. If it should be necessary to remove the knob on a front-panel control, either to replace one that has been damaged or to replace the associated control, proceed as follows:

a. Grasp the knob firmly with the fingers and pull the knob straight away from the panel.

b. Observe the position of the setscrew in the bushing, with respect to any panel marking (or at the full ccw position of a continuous control).

c. Release the setscrew and pull the bushing off the shaft.

NOTE

To separate the bushing from the knob, if for any reason they should be combined off the instrument, drive a machine tap a turn or two into the bushing for a sufficient grip for easy separation.

6.8 KNOB INSTALLATION. To install a knob assembly on the control shaft:

a. Mount the bushing on the shaft, using a small slotted piece of wrapping paper as a shim for adequate panel clearance.

b. Orient the setscrew on the bushing with respect to the panel-marking index and lock the setscrew.

NOTE

Make sure that the end of the shaft does not protrude through the bushing or the knob won't seat properly.

c. Place the knob on the bushing with the retention spring opposite the setscrew.

d. Push the knob in until it bottoms and pull it slightly to check that the retention spring is seated in the groove in the bushing.

NOTE

If the retention spring in the knob comes loose, reinstall it in the interior notch with the small slit in the outer wall.

6.9 MOTOR REPLACEMENT. When a replacement motor is installed in some older Type 1521 recorders, it may be necessary to replace capacitor C1 (see Figure 6.1).

Refer to paragraph 2.1.5 for motor installation instructions. Be sure to observe the motor manufacturer and the value of C1 in the recorder before installing a new motor. To determine if replacement of C1 is necessary, refer to Table 6.6 for the correct capacitor required for each motor manufacturer.

TABLE 6.6
CAPACITOR REQUIREMENTS FOR
REPLACEMENT MOTORS

<i>Motor Mfg.</i>	<i>Capacitor (C1)</i>
Holtzer Cabot*	1.0 μ F or 1.2 μ F
Diehl	1.2 μ F
Bodine	1.2 μ F

*It is not necessary to replace 1.0 μ F capacitor if the motor is manufactured by Holtzer Cabot.

FEDERAL MANUFACTURER'S CODE

From Federal Supply Code for Manufacturers Cataloging Handbooks H4-1
(Name to Code) and H4-2 (Code to Name) as supplemented through August, 1968.

Code	Manufacturer	Code	Manufacturer	Code	Manufacturer
00192	Jones Mfg. Co, Chicago, Illinois	49671	RCA, New York, N.Y. 10020	80431	Air Filter Corp, Milwaukee, Wisc. 53218
00194	Walsco Electronics Corp, L.A., Calif.	49956	Raytheon Mfg Co, Waltham, Mass. 02154	80583	Hammarlund Co, Inc, New York, N.Y.
00434	Schweber Electronics, Westburg, L.I., N.Y.	53021	Sangamo Electric Co, Springfield, Ill. 62705	80740	Beckman Instruments, Inc, Fullerton, Calif.
00656	Aerovox Corp, New Bedford, Mass.	54294	Shallcross Mfg Co, Selma, N.C.	81030	International Instrument, Orange, Conn.
01009	Alden Products Co, Brockton, Mass.	54715	Shure Brothers, Inc, Evanston, Ill.	81073	Grayhill Inc, LaGrange, Ill. 60525
01121	Allen-Bradley, Co, Milwaukee, Wisc.	56289	Sprague Electric Co, N. Adams, Mass.	81143	Isolentite Mfg Corp, Stirling, N.J. 07980
01295	Texas Instruments, Inc, Dallas, Texas	59730	Thomas and Betts Co, Elizabeth, N.J. 07207	81349	Military Specifications
02114	Ferroxcube Corp, Saugerties, N.Y. 12477	59875	TRW Inc, (Accessories Div), Cleveland, Ohio	81350	Joint Army-Navy Specifications
02606	Fenwal Lab Inc, Morton Grove, Ill.	60399	Torrington Mfg Co, Torrington, Conn.	81751	Columbus Electronics Corp, Yonkers, N.Y.
02660	Amphenol Electron Corp, Broadview, Ill.	61637	Union Carbide Corp, New York, N.Y. 10017	81831	Filtron Co, Flushing, L.I., N.Y. 11354
02768	Fastex, Des Plaines, Ill. 60016	61864	United-Carr Fastener Corp, Boston, Mass.	81840	Ledex Inc, Dayton, Ohio 45402
03508	G.E. Semicon Prod, Syracuse, N.Y. 13201	63060	Victoreen Instrument Co, Inc, Cleveland, O.	81860	Barry-Wright Corp, Watertown, Mass.
03636	Grayburne, Yonkers, N.Y. 10701	63743	Ward Leonard Electric Co, Mt. Vernon, N.Y.	82219	Sylvania Elec Prod, Emporium, Penn.
03888	Pyrofilm Resistor Co, Cedar Knolls, N.J.	65083	Westinghouse (Lamp Div), Bloomfield, N.J.	82273	Indiana Pattern & Model Works, LaPort, Ind.
03911	Clairax Corp, New York, N.Y. 10001	65082	Weston Instruments, Newark, N.J.	82389	Switchcraft Inc, Chicago, Ill. 60630
04009	Arrow-Hart & Hegeman, Hartford, Conn. 06106	70485	Atlantic-India Rubber, Chicago, Ill. 60607	82647	Metals & Controls Inc, Attleboro, Mass.
04713	Motorola, Phoenix, Ariz. 85008	70563	Amperite Co, Union City, N.J. 07087	82807	Milwaukee Resistor Co, Milwaukee, Wisc.
05170	Eng'd Electronics, Santa Ana, Calif. 92702	70903	Belden Mfg Co, Chicago, Ill. 60644	83033	Melsner Mfg, (Maguire Ind) Mt. Carmel, Ill.
05624	Barber-Colman Co, Rockford, Ill. 61101	71126	Bronson, Homer D. Co, Beacon Falls, Conn.	83058	Carr Fastener Co, Cambridge, Mass.
05820	Wakefield Eng, Inc, Wakefield, Mass. 01890	71294	Canfield, H.O. Co, Clifton Forge, Va. 24422	83186	Victory Engineering, Springfield, N.J. 07081
07126	Digitron Co, Pasadena, Calif.	71400	Busman (McGraw Edison), St. Louis, Mo.	83361	Bearing Specialty Co, San Francisco, Calif.
07127	Eagle Signal (E.W. Bliss Co), Baraboo, Wisc.	71468	ITT Cannon Elec, L.A., Calif. 90031	83587	Solar Electric Corp, Warren, Penn.
07261	Avnet Corp, Culver City, Calif. 90230	71590	Centralbas, Inc, Milwaukee, Wisc. 53212	83740	Union Carbide Corp, New York, N.Y. 10017
07263	Fairchild Camera, Mountain View, Calif.	71666	Continental Carbon Co, Inc, New York, N.Y.	83781	National Electronics Inc, Geneva, Ill.
07387	Bircher Corp, No. Los Angeles, Calif.	71707	Coto Col Co Inc, Providence, R.I.	84411	TRW Capacitor Div, Ogallala, Nebr.
07595	Amer Semicond, Arlington Hts, Ill. 60004	71744	Chicago Miniature Lamp Works, Chicago, Ill.	84835	Lehigh Metal Prods, Cambridge, Mass. 02140
07828	Bodline Corp, Bridgeport, Conn. 06605	71785	Cinch Mfg Co, Chicago, Ill. 60624	84971	TA Mfg Corp, Los Angeles, Calif.
07829	Bodline Electric Co, Chicago, Ill. 60618	71823	Darnell Corp, Ltd, Downey, Calif. 90241	86577	Precision Metal Prods, Stoneham, Mass. 02180
07910	Cont Device Corp, Hawthorne, Calif.	72136	Electro Motive Mfg Co, Wilmington, Conn.	86684	RCA (Elect. Comp & Dev), Harrison, N.J.
07983	State Labs Inc, N.Y., N.Y. 10003	72259	Nytronics Inc, Berkeley Heights, N.J. 07922	86687	REC Corp, New Rochelle, N.Y. 10801
07999	Borg Inst., Delavan, Wisc. 53115	72619	Dialight Co, Brooklyn, N.Y. 11237	86800	Cont Electronics Corp, Brooklyn, N.Y. 11222
08730	Vermaline Prod Co, Franklin Lakes, N.J.	72699	General Instr Corp, Newark, N.J. 07104	88140	Cutler-Hammer Inc, Lincoln, Ill.
09213	G.E. Semiconductor, Buffalo, N.Y.	72765	Drake Mfg Co, Chicago, Ill. 60656	88219	Gould Nat. Batteries Inc, Trenton, N.J.
09408	Star-Tronics Inc, Georgetown, Mass. 01830	72825	Hugh H. Eby Inc, Philadelphia, Penn. 19144	88419	Cornell-Dubilier, Fuquay-Varina, N.C.
09823	Burgess Battery Co, Freeport, Ill.	72962	Erie Tech Stop Nut Corp, Union, N.J. 07083	88627	K & G Mfg Co, New York, N.Y.
09922	Burndy Corp, Norwalk, Conn. 06852	72982	Elastic Technological Products Inc, Erie, Penn.	89482	Holtzer-Cabot Corp, Boston, Mass.
11236	C.T.S. of Berns, Inc, Berns, Ind. 46711	73138	Beckman Inc, Fullerton, Calif. 92634	89665	United Transformer Co, Chicago, Ill.
11599	Chandler Evans Corp, W. Hartford, Conn.	73445	Amperex Electronics Co, Hicksville, N.Y.	90201	Mallory Capacitor Co, Indianapolis, Ind.
12040	National Semiconductor, Danbury, Conn.	73559	Carling Electric Co, W.Hartford, Conn.	90750	Westinghouse Electric Corp, Boston, Mass.
12498	Crystallonics, Cambridge, Mass. 02140	73690	Elco Resistor Co, New York, N.Y.	90952	Hardware Products Co, Reading, Penn. 19602
12672	RCA, Woodbridge, N.J.	73899	JFD Electronics Corp, Brooklyn, N.Y.	91032	Continental Wire Corp, York, Penn. 17405
12697	Clarostat Mfg Co, Inc, Dover, N.H. 03820	74193	Heinemann Electric Co, Trenton, N.J.	91146	ITT (Cannon Electric Inc), Salem, Mass.
12954	Dickson Electronics, Scottsdale, Ariz.	74861	Industrial Condenser Corp, Chicago, Ill.	91293	Johanson Mfg Co, Boonton, N.J. 07005
13327	Solltron Devices, Tappan, N.Y. 10983	74970	E.F. Johnson Co, Wesaca, Minn. 56093	91506	Augat Inc, Attleboro, Mass. 02703
14433	ITT Semiconductors, W.Palm Beach, Fla.	75042	IRC Inc, Philadelphia, Penn. 19108	91598	Chandler Co, Wethersfield, Conn. 06109
14655	Cornell-Dubilier Electric Co, Newark, N.J.	75382	Kulka Electric Corp, Mt. Vernon, N.Y.	91637	Dale Electronics Inc, Columbus, Nebr.
14674	Corning Glass Works, Corning, N.Y.	75491	Lafayette Industrial Electronics, Jamaica, N.Y.	91662	Elco Corp, Willow Grove, Penn.
14936	General Instrument Corp, Hicksville, N.Y.	75608	Linden and Co, Providence, R.I.	91719	General Instruments, Inc, Dallas, Texas
15238	ITT, Semiconductor Div, Lawrence, Mass.	75915	Littelfuse, Inc, Des Plaines, Ill. 60016	91929	Honeywell Inc, Freeport, Ill.
15605	Cutler-Hammer Inc, Milwaukee, Wisc. 53233	76005	Lord Mfg Co, Erie, Penn. 16512	92519	Electra Insul Corp, Woodside, L.I., N.Y.
16037	Spruce Pine Mica Co, Spruce Pine, N.C.	76149	Mallory Electric Corp, Detroit, Mich. 48204	92678	E.G.&G., Boston, Mass.
17771	Singer Co, Diehl Div, Somerville, N.J.	76487	James Millen Mfg Co, Malden, Mass. 02148	93332	Sylvania Elect Prods, Inc, Woburn, Mass.
19396	Illinois Tool Works, Pakton Div, Chicago, Ill.	76545	Mueller Electric Co, Cleveland, Ohio 44114	93916	Cramer Products Co, New York, N.Y. 10013
19644	LRC Electronics, Horseheads, N.Y.	76684	National Tube Co, Pittsburg, Penn.	94144	Raytheon Co, Components Div, Quincy, Mass.
19701	Electra Mfg Co, Independence, Kansas 67301	76854	Oak Mfg Co, Crystal Lake, Ill.	94154	Tung Sol Electric Inc, Newark, N.J.
21335	Fafnir Bearing Co, New Briton, Conn.	77147	Patton MacGuyver Co, Providence, R.I.	95076	Garde Mfg Co, Cumberland, R.I.
22753	UID Electronics Corp, Hollywood, Fla.	77166	Pass-Seymour, Syracuse, N.Y.	95121	Quality Components Inc, St. Mary's, Penn.
23342	Avnet Electronics Corp, Franklin Park, Ill.	77263	Pierce Roberts Rubber Co, Trenton, N.J.	95146	Alco Electronics Mfg Co, Lawrence, Mass.
24446	G.E., Schenectady, N.Y. 12305	77339	Positive Lockwasher Co, Newark, N.J.	95238	Continental Connector Corp, Woodside, N.Y.
24454	G.E., Electronics Comp, Syracuse, N.Y.	77542	Ray-O-Vac Co, Madison, Wisc.	95275	Vitramon, Inc, Bridgeport, Conn.
24455	G.E. (Lamp Div), Nela Park, Cleveland, Ohio	77630	TRW, Electronic Comp, Camden, N.J. 08103	95364	Methode Mfg Co, Chicago, Ill.
24655	General Radio Co, W. Concord, Mass. 01781	77638	General Instruments Corp, Brooklyn, N.Y.	95412	General Electric Co, Schenectady, N.Y.
26806	American Zettlet Inc, Costa Mesa, Calif.	78189	Shakeproof (Ill. Tool Works), Elgin, Ill. 60120	95794	Anaconda Amer Brass Co, Torrington, Conn.
28520	Hayman Mfg Co, Kenilworth, N.J.	78277	Sigma Instruments Inc, S.Braintree, Mass.	96095	HI-Q Div. of Aerovox Corp, Orlan, N.Y.
28959	Hoffman Electronics Corp, El Monte, Calif.	78488	Stackpole Carbon Co, St. Marys, Penn.	96214	Texas Instruments Inc, Dallas, Texas 75209
30874	I.B.M., Armonk, New York	78553	Tinnerman Products, Inc, Cleveland, Ohio	96256	Thorderson-Melsner, Mt. Carmel, Ill.
32001	Jensen Mfg. Co, Chicago, Ill. 60638	79089	RCA, Rec Tube & Semicond, Harrison, N.J.	96341	Microwave Associates Inc, Burlington, Mass.
33173	G.E. Comp, Owensboro, Ky. 42301	79725	Wiremold Co, Hartford, Conn. 06110	96791	Amphenol Corp, Jonesville, Wisc. 53545
35929	Constanta Co, Mont. 19, Que.	79963	Zierick Mfg Co, New Rochelle, N.Y.	96906	Military Standards
37942	P.R. Mallory & Co Inc, Indianapolis, Ind.	80030	Prestole Fastener, Toledo, Ohio	98291	Sealstro Corp, Mamaroneck, N.Y. 10544
38443	Marlin-Rockwell Corp, Jamestown, N.Y.	80048	Vickers Inc, St. Louis, Mo.	98474	Compar Inc, Burlingame, Calif.
40931	Honeywell Inc, Minneapolis, Minn. 55408	80131	Electronic Industries Assoc, Washington, D.C.	98821	North Hills Electronics Inc, Glen Cove, N.Y.
42190	Muter Co, Chicago, Ill. 60638	80183	Sprague Products Co, No. Adams, Mass.	99180	Transitron Electronics Corp, Melrose, Mass.
42498	National Co, Inc, Melrose, Mass. 02176	80211	Motrolia Inc, Franklin Park, Ill. 60131	99313	Varian, Palo Alto, Calif. 94303
43991	Norma-Hoffman, Stanford, Conn. 06904	80258	Standard Oil Co, Lafayette, Ind.	99378	Atlee Corp, Winchester, Mass. 01890
		80294	Bourns Inc, Riverside, Calif. 92506	99800	Delevan Electronics Corp, E. Aurora, N.Y.

MARKER-HOLDER ASSEMBLY

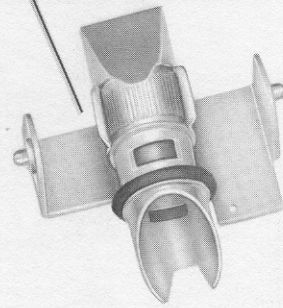

MARKER

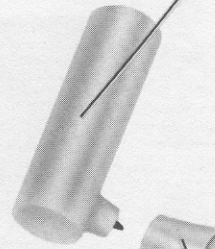

SPRING



CAP



Figure 6.4. Components of the fastrak Marker Conversion Kit.

**PARTS LIST
ACCESSORIES**

<i>Quantity</i>	<i>Description</i>	<i>GR Part No.</i>	<i>FMC</i>	<i>Mfg Part No.</i>	<i>Fed Stock No.</i>
	End-Frame Set, complete (refer paragraph 2.1.1)	5310-9650	24655	5310-9650	
1	End-Frame Assembly, right-hand	5310-5100	24655	5310-5100	
1	End-Frame Assembly, left-hand	5310-5101	24655	5310-5101	
4	Foot (part of end-frame assembly)	5260-0710	24655	5260-0710	
1	Hardware Set, complete	5310-3300	24655	5310-3300	
8	Clamp, aluminum	5310-6310	24655	5310-6310	
8	Screw, Phillips-head, 10-32, 3/8 inch	7080-1000	24655	7080-1000	
4	Panel Screw, Phillips-head, 10-32, 5/8 inch, with nylon cup washer	7270-6210	24655	7270-6210	
	Stacking Set, complete (refer paragraph 2.4)	5310-3304	24655	5310-3304	
4	Nut, No. 10, locking	5820-0500	24655	5820-0500	
4	Screw, Phillips-head, 10-32, 1 inch	7080-3200	24655	7080-3200	
4	Spacer, aluminum, No. 10, 15/32 inch	7660-2015	24655	7660-2015	
	Rack Support Set, complete	7863-9650	24655	7863-9650	
1	Support, right-hand	7863-8650	24655	7863-8650	
1	Support, left-hand	7863-8750	24655	7863-8750	
1	Instruction Sheet, installation	7863-0100	24655	7863-0100	
1	Hardware Set, complete	7863-3001	24655	7863-3001	
4	Thumbscrew, 10-32, 1/4 inch	7270-3800	24655	7270-3800	
4	Panel Screw, Phillips-head, 10-32, 5/8 inch, with cup washer	7270-6210	24655	7270-6210	
4	Screw, slotted-head, 10-32, 5/8 inch	7160-0325	24655	7160-0325	
4	Washer, flat, No. 10, 1/16-inch thick	8100-1517	24655	8100-1517	
	Marker Conversion Kit, fastrak, complete, (see figure 6.4)	1521-9439	24655	1521-9439	
1	Marker-Set Combination	1521-9449	24655	1521-9449	
1	Marker-Holder Assembly	1521-2439	24655	1521-2439	
2	Spring	1521-8221	24655	1521-8221	
1	Instruction Sheet, installation	1521-0108	24655	1521-0108	
1	Etched-Circuit Assembly, complete (see figure 6.7)	1521-2721	24655	1521-2721	

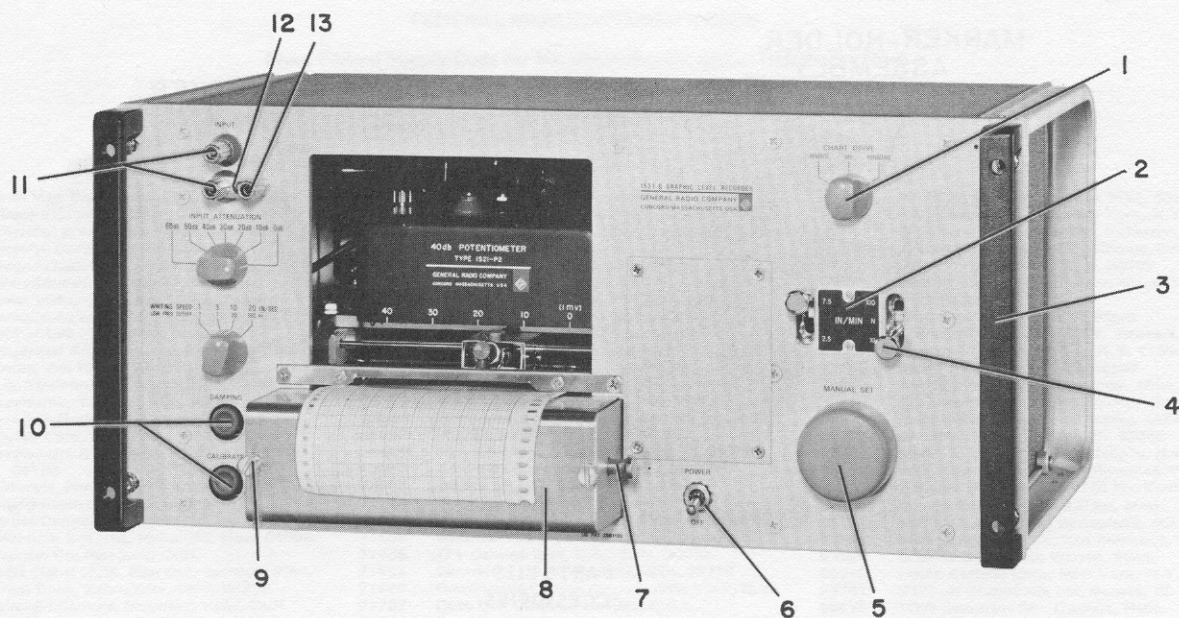

Figure 6.5. Type 1521-B mechanical replacement parts (refer to Parts List).

PARTS LIST
REPLACEMENT PARTS, Mechanical (see Figure 6.5)

Quantity	Description	GR Part No.	FMC	Mfg Part No.	Fed. Stock No.
3	Knob Assembly, complete, CHART DRIVE (1, figure 6.5) (Same assembly required for WRITING SPEED and INPUT ATTENUATION controls)	5500-5321	24655	5500-5321	
1	Knob, bar (part of 5500-5321)	5500-5301	24655	5500-5301	
1	Fastener, retainer (part of 5500-5321)	5220-5402	24655	5220-5402	
1	Label, aluminum, 0.5 and 1.5 IN/MIN	1521-8392	24655	1521-8392	
1	Label, aluminum, 2.5 and 7.5 IN/MIN (4, Figure 6.5)	1521-8390	24655	1521-8390	
1	Label, aluminum, 2.5 and 7.5 IN/HR	1521-8391	24655	1521-8391	
2	Knob, shift-lever (2, Figure 6.5)	1521-6090	24655	1521-6090	
2	Handle (3, Figure 6.5)	5360-2022	24655	5360-2022	
1	Knob Assembly, complete, MANUAL SET (5, Figure 6.5)	5520-5520	24655	5520-5520	
1	Knob, round (part of 5520-5520)	5520-5500	24655	5520-5500	
1	Fastener, retainer (part of 5520-5520)	5220-5401	24655	5220-5401	
1	Nut, dress, used with POWER/OFF switch (6, Figure 6.5)	5800-0800	24655	5800-0800	5310-344-3634
1	Knob (7, Figure 6.5)	1521-6110	24655	1521-6110	
1	Cover, chart paper (8, Figure 6.5)	1521-8260	24655	1521-8260	
2	Thumb Screw, 3/8 (9, Figure 6.5)	7270-3900	24655	7270-3900	
2	Knob, thumb-set, gray, for DAMPING and CALIBRATE controls (10, Figure 6.5)	5540-2500	24655	5540-2500	
2	Binding Post, insulated, INPUT (11, Figure 6.5)	0938-3000	24655	0938-3000	
1	Connecting Link, ground (12, Figure 6.5)	5080-4800	24655	5080-4800	5940-927-7452
1	Binding Post, ground, INPUT (13, Figure 6.5)	0938-3022	24655	0938-3022	

PARTS LIST

RESISTORS

Ref No.	Description	GR Part No.	FMC	Mfg Part No.	Fed Stock No.
R1	Film, 13.0 kΩ ±1% 1 W	6550-2130	75042	MEF, 13.0 kΩ ±1%	5905-552-6033
R2	Film, 30.1 kΩ ±1% 1/2 W	6450-2301	75042	CEC, 30.1 kΩ ±1%	5905-556-3783
R3	Film, 21.0 kΩ ±1% 1/2 W	6450-2210	75042	CEC, 21.0 kΩ ±1%	5905-581-1526
R4	Film, 28.7 kΩ ±1% 1/8 W	6250-2287	75042	CEA, 28.7 kΩ ±1%	5905-691-0572
R5	Film, 19.6 kΩ ±1% 1/2 W	6450-2196	75042	CEC, 19.6 kΩ ±1%	5905-581-1023
R6	Film, 28.7 kΩ ±1% 1/8 W	6250-2287	75042	CEA, 28.7 kΩ ±1%	5905-691-0572
R7	Film, 19.6 kΩ ±1% 1/2 W	6450-2196	75042	CEC, 19.6 kΩ ±1%	5905-581-1023
R8	Film, 28.7 kΩ ±1% 1/8 W	6250-2287	75042	CEA, 28.7 kΩ ±1%	5905-691-0572
R9	Film, 19.1 kΩ ±1% 1/2 W	6450-2191	75042	CEC, 19.1 kΩ ±1%	5905-581-1716
R10	Film, 28.7 kΩ ±1% 1/8 W	6250-2287	75042	CEA, 28.7 kΩ ±1%	5905-691-0572
R11	Film, 22.6 kΩ ±1% 1/4 W	6350-2226	75042	CEB, 22.6 kΩ ±1%	
R12	Film, 21.5 kΩ ±1% 1/8 W	6250-2215	75042	CEA, 21.5 kΩ ±1%	5905-615-7339
R13	Potentiometer, Wire-wound, 10 kΩ (20 dB), Type 1521-P1	1521-9601	24655	1521-9601	5905-448-5331
	10 kΩ (40 dB), Type 1521-P2 (normally supplied)	1521-9602	24655	1521-9602	5905-448-5335
	10 kΩ (80 dB), Type 1521-P3	1521-9603	24655	1521-9603	5905-448-5334
	dc Linear, Type 1521-P4	1521-9604	24655	1521-9604	
R14†	Potentiometer, Wire-wound, 1 kΩ ±1%	1521-9604	24655	1521-9604	
R15†	Composition, 5.76 kΩ ±1%				
R16†	Potentiometer, Wire-wound, 5 kΩ ±10%				
R17†	Composition, 430 Ω ±5% 1/2 W				
R18†	Composition, 1 kΩ ±5% 1/2 W				
R19†	Potentiometer, Composition, 1 kΩ ±10%				
R20	Composition, 51 Ω ±5% 1/2 W	6100-0515	01121	RC20GF510J	5905-279-3517
R21	Potentiometer, Composition, 2.5 kΩ ±10%	6030-0200	01121	JU, 2.5 kΩ ±10%	5905-780-9769
R22	Potentiometer, Wire-Wound, 250 Ω ±10%				
R23	Composition, 1.5 kΩ ±5% 1/2 W	6050-0900	12697	43, 250 Ω ±10%	
R24	Composition, 10 kΩ ±5% 1/2 W	6100-2155	01121	RC20GF152J	5905-841-7461
R25	Power, 1.8 kΩ ±5% 10 W	6100-3105	01121	RC20GF103J	5905-185-8510
R26	Power, 1.8 kΩ ±5% 10 W	6670-9185	80183	247E, 1.8 Ω ±5%	5905-448-5685
R27	Composition, 270 Ω ±5% 1/2 W	6100-1275	01121	RC20GF271J	5905-171-2006
R28	Power, 22 Ω ±5% 5 W	6660-0225	80183	246E, 22 Ω ±5%	5905-448-5687
R29	Power, 82 Ω ±5% 10 W	6670-0825	80183	247E, 82 Ω ±5%	5905-448-5692
R30	Power, 82 Ω ±5% 10 W	6670-0825	80183	247E, 82 Ω ±5%	5905-448-5692
R31	Composition, 30 Ω ±5% 2 W	6120-0305	01121	RC42GF300J	5905-279-3415
R32†	Composition, 2.7 kΩ ±10% 1 W	6110-2279	01121	GB, 2.7 kΩ ±10%	
R33†	Composition, 82 Ω ±5% 1/2 W				
R100	Composition, 100 Ω ±5% 1/2 W	6100-1105	01121	RC20GF101J	5905-190-8889
R101	Composition, 51 kΩ ±5% 1/2 W	6100-3515	01121	RC20GF513J	5905-279-3496
R102	Composition, 620 kΩ ±5% 1/2 W	6100-4625	01121	RC20GF624J	5905-221-5841
R103	Composition, 150 kΩ ±5% 1/2 W	6100-4155	01121	RC20GF154J	5905-279-2522
R104	Composition, 10 kΩ ±5% 1/2 W	6100-3105	01121	RC20GF103J	5905-185-8510
R105	Composition, 5.1 kΩ ±5% 1/2 W	6100-2515	01121	RC20GF512J	5905-279-2019
R106	Composition, 10 kΩ ±5% 1/2 W	6100-3105	01121	RC20GF103J	5905-185-8510
R107	Composition, 470 Ω ±5% 1/2 W	6100-1475	01121	RC20GF471J	5905-192-3973
R108	Composition, 10 kΩ ±5% 1/2 W	6100-3105	01121	RC20GF103J	5905-185-8510
R109	Composition, 430 Ω ±5% 1/2 W	6100-1435	01121	RC20GF431J	5905-279-3512
R110	Composition, 10 kΩ ±5% 1/2 W	6100-3105	01121	RC20GF103J	5905-185-8510
R111	Composition, 10 kΩ ±5% 1/2 W	6100-3105	01121	RC20GF103J	5905-185-8510
R112	Composition, 3.9 kΩ ±5% 1/2 W	6100-2395	01121	RC20GF392J	5905-279-3505
R113	Composition, 12 kΩ ±5% 1/2 W	6100-3125	01121	RC20GF123J	5905-279-3502
R114	Composition, 6.2 kΩ ±5% 1/2 W	6100-2625	01121	RC20GF622J	5905-279-2673
R115	Potentiometer, Composition, 5 kΩ ±20%	6040-0600	01121	FWC, 5 kΩ ±20%	5905-034-5374
R116	Composition, 1.5 kΩ ±5% 1/2 W	6100-2155	01121	RC20GF152J	5905-841-7461
R117	Composition, 6.8 kΩ ±5% 1/2 W	6100-2685	01121	RC20GF682J	5905-279-3503

† Part of Type 1521-P4

PARTS LIST (Cont.)

RESISTORS (Cont.)

Ref No.	Description	GR Part No.	FMC	Mfg Part No.	Fed Stock No.
R118	Composition, 12 k Ω \pm 5% 1/2 W	6100-3125	01121	RC20GF123J	5905-279-3502
R119	Composition, 1.5 k Ω \pm 5% 1/2 W	6100-2155	01121	RC20GF152J	5905-841-7461
R120	Composition, 8.2 k Ω \pm 5% 1/2 W	6100-2825	01121	RC20GF822J	5905-299-1971
R121	Composition, 220 Ω \pm 5% 1/2 W	6100-1225	01121	RC20GF221J	5905-279-3513
R122	Composition, 5.1 k Ω \pm 5% 1/2 W	6100-2515	01121	RC20GF512J	5905-279-2019
R123	Composition, 2.4 k Ω \pm 5% 1/2 W	6100-2245	01121	RC20GF242J	5905-279-1877
R124	Composition, 3 k Ω \pm 5% 1/2 W	6100-2305	01121	RC20GF302J	5905-279-1751
R125	Composition, 2 k Ω \pm 5% 1/2 W	6100-2205	01121	RC20GF202J	5905-190-8887
R126	Composition, 120 k Ω \pm 5% 1/2 W	6100-4125	01121	RC20GF124J	5905-192-3981
R127	Composition, 820 k Ω \pm 5% 1/2 W	6100-1825	01121	RC20GF821J	5905-171-1999
R128	Composition, 6.8 k Ω \pm 5% 1/2 W	6100-2685	01121	RC20GF682J	5905-279-3503
R129	Composition, 820 Ω \pm 5% 1/2 W	6100-1825	01121	RC20GF821J	5905-171-1999
R130	Composition, 6.8 k Ω \pm 5% 1/2 W	6100-2685	01121	RC20GF682J	5905-279-3503
R131	Composition, 820 Ω \pm 5% 1/2 W	6100-1825	01121	RC20GF821J	5905-171-1999
R132	Composition, 82 k Ω \pm 5% 1/2 W	6100-3825	01121	RC20GF823J	5905-279-3494
R133	Composition, 20 k Ω \pm 5% 1/2 W	6100-3205	01121	RC20GF203J	5905-192-0649
R134	Composition, 82 k Ω \pm 5% 1/2 W	6100-3825	01121	RC20GF823J	5905-279-3494
R135	Composition, 20 k Ω \pm 5% 1/2 W	6100-3205	01121	RC20GF203J	5905-192-0649
R136	Composition, 20 k Ω \pm 5% 1/2 W	6100-3205	01121	RC20GF203J	5905-192-0649
R137	Potentiometer, Composition, 250 Ω \pm 10%	6010-0200	24655	6010-0200	5905-055-5061
R138	Composition, 240 Ω \pm 5% 1/2 W	6100-1245	01121	RC20GF241J	5905-279-2593
R139	Potentiometer, Composition, 500 Ω \pm 10%	6010-0300	01121	JU, 500 Ω \pm 10%	5905-448-5741
R140	Composition, 470 Ω \pm 5% 1/2 W	6100-1475	01121	RC20GF471J	5905-192-3973
R141	Composition, 240 Ω \pm 5% 1/2 W	6100-1245	01121	RC20GF241J	5905-279-2593
R142	Composition, 3.6 k Ω \pm 5% 1/2 W	6100-2365	01121	RC20GF362J	5905-171-2001
R143	Composition, 36 k Ω \pm 5% 1/2 W	6100-3365	01121	RC20GF363J	5905-249-4256
R144	Composition, 36 k Ω \pm 5% 1/2 W	6100-3365	01121	RC20GF363J	5905-249-4256
R145	Composition, 9.1 k Ω \pm 5% 1/2 W	6100-2915	01121	RC20GF912J	5905-249-4200
R146	Composition, 9.1 k Ω \pm 5% 1/2 W	6100-2915	01121	RC20GF912J	5905-249-4200
R147	Composition, 18 k Ω \pm 5% 1/2 W	6100-3185	01121	RC20GF183J	5905-279-3500
R148	Composition, 12 k Ω \pm 5% 1/2 W	6100-3125	01121	RC20GF123J	5905-279-3502
R149	Composition, 9.1 k Ω \pm 5% 1/2 W	6100-2915	01121	RC20GF912J	5905-249-4200
R150	Composition, 18 k Ω \pm 5% 1/2 W	6100-3185	01121	RC20GF183J	5905-279-3500
R151	Composition, 18 k Ω \pm 5% 1/2 W	6100-3185	01121	RC20GF183J	5905-279-3500
R152	Composition, 33 k Ω \pm 5% 1/2 W	6100-3335	01121	RC20GF333J	5905-171-1998
R153	Composition, 10 k Ω \pm 5% 1/2 W	6100-3105	01121	RC20GF103J	5905-185-8510
R154	Composition, 10 k Ω \pm 5% 1/2 W	6100-3105	01121	RC20GF103J	5905-185-8510
R155	Composition, 10 k Ω \pm 5% 1/2 W	6100-3105	01121	RC20GF103J	5905-185-8510
R156	Composition, 1.6 k Ω \pm 5% 1/2 W	6100-2165	01121	RC20GF162J	5905-279-3507
R157	Composition, 1.6 k Ω \pm 5% 1/2 W	6100-2165	01121	RC20GF162J	5905-279-3507
R158	Composition, 1 k Ω \pm 5% 1/2 W	6100-2105	01121	RC20GF102J	5905-195-6806
R159	Composition, 820 Ω \pm 5% 1/2 W	6100-1825	01121	RC20GF821J	5905-171-1999
R160	Composition, 910 Ω \pm 5% 1/2 W	6100-1915	01121	RC20GF911J	5905-279-3509
R161	Composition, 430 Ω \pm 5% 1/2 W	6100-1435	01121	RC20GF431J	5905-279-3512
R163	Composition, 470 k Ω \pm 5% 1/2 W	6100-4475	01121	RC20GF474J	5905-279-2515
R164	Composition, 180 Ω \pm 5% 1/2 W	6100-1185	01121	RC20GF181J	5905-279-3514
R165	Composition, 18 k Ω \pm 5% 1/2 W	6100-3185	01121	RC20GF183J	5905-279-3500
R166	Composition, 2 k Ω \pm 5% 1/2 W	6100-2205	01121	RC20GF202J	5905-190-8887
R167	Composition, 5.6 k Ω \pm 5% 1/2 W	6100-2565	01121	RC20GF562J	5905-195-6453
R168	Potentiometer, Composition, 2.5 k Ω \pm 10%	6010-0700	01121	JU, 2.5 k Ω \pm 10%	
R169	Composition, 10 k Ω \pm 5% 1/2 W	6100-3105	01121	RC20GF103J	5905-185-8510
R170	Composition, 6.8 k Ω \pm 5% 1/2 W	6100-2685	01121	RC20GF682J	5905-279-3503
R171	Composition, 51 Ω \pm 5% 1/2 W	6100-0515	01121	RC20GF510J	5905-279-3517
R172	Composition, 510 Ω \pm 5% 1/2 W	6100-1515	01121	RC20GF511J	5905-279-3511
R173	Composition, 120 Ω \pm 5% 1/2 W	6100-1125	01121	RC20GF121J	5905-252-5434
R174	Composition, 150 k Ω \pm 5% 1/2 W	6100-4155	01121	RC20GF154J	5905-279-2522

PARTS LIST (Cont.)

Ref No.	CAPACITORS	GR Part No.	FMC	Mfg Part No.	Fed Stock No.
C1	Electrolytic, 1.0 μ F +10-5% 220 V ac	4510-5020	93916	CD, 1.0 μ F +10-5%	
C2A	Electrolytic, 450 μ F 100 V				
C2B	Electrolytic, 225 μ F 100 V	4450-4000	74861	1B85 ORT	5910-448-5397
C2C	Electrolytic, 225 μ F 100 V				
C3A	Electrolytic, 450 μ F 100 V				
C3B	Electrolytic, 225 μ F 100 V	4450-4000	74861	1B85 ORT	5910-448-5397
C3C	Electrolytic, 225 μ F 100 V				
C4A	Electrolytic, 300 μ F 150 V				
C4B	Electrolytic, 150 μ F 150 V	4450-5602	37942	20-22287991	5910-931-7039
C4C	Electrolytic, 150 μ F 150 V				
C5	Ceramic, 22 pF \pm 10% 500 V	4400-3600	00656	NPOK, 22 pF \pm 10%	
C7	Ceramic, 22 pF \pm 10% 500 V	4400-3600	00656	NPOK, 22 pF \pm 10%	
C8	Ceramic, 0.022 μ F +80-20% 1000 V	4407-3229	72982	CC63, 0.022 μ F +80-20%	5910-842-2961
C9	Ceramic, 0.022 μ F +80-20% 1000 V	4407-3229	72982	CC63, 0.022 μ F +80-20%	5910-842-2961
C10	Electrolytic, 0.47 μ F \pm 20% 75 V	4450-4310	56289	150D47X0075A2	
C11	Electrolytic, 0.47 μ F \pm 20% 75 V	4450-4310	56289	150D47X0075A2	
C12	Electrolytic, 2.2 μ F \pm 20% 20 V	4450-4500	56289	150D225X0020A2	5910-976-4604
C13	Electrolytic, 2.2 μ F \pm 20% 20 V	4450-4500	56289	150D225X0020A2	5910-976-4604
C101	Wax, 1.0 μ F \pm 10% 100 V	5010-3700	80183	78P10571S3	5910-615-5255
C102	Electrolytic, 5 μ F 50 V	4450-3900	37942	2040595S9C10X3	5910-448-5527
C103	Electrolytic, 60 μ F 25 V	4450-2900	80183	D17873	5910-799-9280
C104	Electrolytic, 5 μ F 50 V	4450-3900	37942	2040595S9C10X3	5910-448-5527
C105	Electrolytic, 600 μ F 3 V	4450-5589	37942	TCM, 600 μ F 3 V	
C107	Electrolytic, 200 μ F 12 V	4450-0400	37942	97679	5910-799-9281
C109	Electrolytic, 60 μ F 25 V	4450-2900	80183	D17873	5910-799-9280
C110	Electrolytic, 22 μ F \pm 20% 15 V	4450-5300	56289	150D226X0015B2	5910-752-4270
C111	Electrolytic, 600 μ F 3 V	4450-5589	37942	TCM, 600 μ F, 3 V	
C112	Electrolytic, 100 μ F 25 V	4450-2300	76149	20-40595	5910-799-9284
C113	Electrolytic, 100 μ F 25 V	4450-2300	76149	20-40595	5910-799-9284
C114	Mica, 0.00185 μ F \pm 2% 100 V	4590-0800	14655	5A, 0.00185 μ F \pm 2%	5910-448-5385
C115	Electrolytic, 2.2 μ F \pm 20% 20 V	4450-4500	56289	150D225X0020A2	5910-976-4604
C116	Electrolytic, 60 μ F 25 V	4450-2900	80183	D17873	5910-799-9280
C118	Electrolytic, 25 μ F 50 V	4450-3000	80183	D33883	5910-799-9285
C119	Electrolytic, 22 μ F \pm 20% 15 V	4450-5300	56289	150D226X0015B2	5910-752-4270
C120	Electrolytic, 22 μ F \pm 20% 15 V	4450-5300	56289	150D226X0015B2	5910-752-4270
C121	Paper, 0.22 μ F \pm 10% 100 V	4860-7981	84411	620S22491	5910-957-6509
C122	Paper, 0.22 μ F \pm 10% 100 V	4860-7981	84411	620S22491	5910-957-6509
C123	Wax, 0.47 μ F \pm 10% 100 V	5010-3600	80183	78P4741S3	5910-448-5765
C124	Wax, 0.01 μ F \pm 10% 100 V	5010-1600	80183	78P1031S3	5910-448-5778
C125	Wax, 1.0 μ F \pm 10% 100 V	5010-3700	80183	78P10571S3	5910-448-5386
C126	Wax, 0.01 μ F \pm 10% 100 V	5010-1600	80183	78P1031S3	5910-448-5778
C127	Electrolytic, 25 μ F 25 V	4450-3000	80183	D33883	5910-799-9285
C128	Wax, 0.1 μ F \pm 10% 100 V	5010-2700	56289	78P10491S3	5910-448-5758
C129	Wax, 0.1 μ F \pm 10% 100 V	5010-2700	56289	78P10491S3	5910-448-5758
C130	Paper, 0.022 μ F \pm 10% 100 V	4860-7860	84411	663UW, 0.022 μ F \pm 10%	
C131	Ceramic, 0.1 μ F +80-20%	4403-4100	80183	CC63, 0.1 μ F +80-20%	5910-811-4788

PARTS LIST (Cont.)

MISCELLANEOUS					
Ref No.	DIODES	GR Part No.	FMC	Mfg Part No.	Fed Stock No.
CR1	Type 1N3253	6081-1001	79089	1N3253	5961-814-4251
CR2	Type 1N3253	6081-1001	79089	1N3253	5961-814-4251
CR101	Type 1N191	6082-1008	93916	1N191	5961-296-3360
CR102	Type 1N191	6082-1008	93916	1N191	5961-296-3360
CR103	Type 1N191	6082-1008	93916	1N191	5961-296-3360
CR104	Type 1N191	6082-1008	93916	1N191	5961-296-3360
CR105	Type 1N645	6082-1016	24446	1N645	5961-944-8222
CR106	Type 1N645	6082-1016	24446	1N645	5961-944-8222
CR107	Type 1N957B	6083-1009	07910	1N957B	
CR108	Type 1N645	6082-1016	24446	1N645	5961-944-8222
CR109	Type 1N645	6082-1016	24446	1N645	5961-944-8222
F1	FUSE, 0.5 A, Slo Blo (115 V)	5330-1000	71400	MDL, 0.5 Amp.	5920-199-9498
F1	FUSE, 0.25 A, Slo Blo (230 V)	5330-0700	71400	MDL, 0.25 Amp.	5920-933-5435
F2	FUSE, 0.5 A, Slo Blo (115 V)	5330-1000	71400	MDL, 0.5 Amp.	5920-199-9498
F2	FUSE, 0.25 A, Slo Blo (230 V)	5330-0700	71400	MDL, 0.25 Amp.	5920-933-5435
J1	BINDING POST, insulated, gray	0938-3000	24655	0938-3000	
J2	BINDING POST, insulated, gray	0938-3000	24655	0938-3000	
J3	BINDING POST, around	0938-3022	24655	0938-3022	
	High-Speed, 60 Hz (normally supplied)	1521-9619	24655	1521-9619	
	High-Speed, 50 Hz	1521-9921	24655	1521-9921	
MO1	MOTOR				
	Medium-Speed, 60 Hz	1521-9623	24655	1521-9623	
	Medium-Speed, 50 Hz	1521-9624	24655	1521-9624	
	Low-Speed, 60 Hz	1521-9513	24655	1521-9513	
	Low-Speed, 50 Hz	1521-9622	24655	1521-9622	
P1	PILOT LAMP, Mazda Type 44	5600-0700	24454	MAZDA 44	6240-057-2887
P2	PILOT LAMP, Mazda Type 44	5600-0700	24454	MAZDA 44	6240-057-2887
PL1	PLUG	1521-2000	24655	1521-2000	
PL4	PLUG	4240-0702	24655	4240-0702	
S1	SWITCH, Rotary, 7-position	7890-1890	76854	Type H	5930-448-5797
S2	SWITCH, Rotary, 4-position	7890-1900	76854	Type H	5930-448-5798
S3	SWITCH, Rotary, 4-position	7890-3900	76854	Type F	
S4	SWITCH, Rotary, 3-position	7890-1920	76854	Type H	5930-448-5947
S5	SWITCH, Toggle, 2-position	7910-1300	04009	83053-SA	5930-909-3510
S6	SWITCH, Toggle, 2-position	7910-1000	04009	83050-S	5930-958-7967
S7*	SWITCH, Mechanical (1521-P10-44)	1521-0441	24655	1521-0441	
S8*	SWITCH, Mechanical (1521-P10-44)	1521-0441	24655	1521-0441	
T1	TRANSFORMER, Power	0345-4770	24655	0345-4770	5950-448-5829
Q1	TRANSISTORS, Type 2N176	8210-1760	04713	2N176	
Q2	TRANSISTORS, Type 2N176	8210-1760	04713	2N176	
Q3	TRANSISTORS, Type 2N176	8210-1760	04713	2N176	
Q101	TRANSISTORS, Type SE4002	8210-1077	24454	2N3390	
Q102**	TRANSISTORS, Type 2N169A	8210-1692	24454	4JX2D739	
Q103**	TRANSISTORS, Type 2N169A	8210-1692	24454	4JX2D739	
Q104**	TRANSISTORS, Type 2N169A	8210-1692	24454	4JX2D739	
Q105**	TRANSISTORS, Type 2N169A	8210-1692	24454	4JX2D739	
Q106**	TRANSISTORS, Type 2N169A	8210-1692	24454	4JX2D739	
Q107**	TRANSISTORS, Type 2N169A	8210-1692	24454	4JX2D739	
Q108	TRANSISTORS, Type 2N338	8210-1021	01295	2N2349	5961-967-1343
Q109	TRANSISTORS, Type 2N338	8210-1021	01295	2N2349	5961-967-1343
Q110	TRANSISTORS, Type 2N338	8210-1021	01295	2N2349	5961-967-1343
Q111	TRANSISTORS, Type 2N338	8210-1021	01295	2N2349	5961-967-1343
Q112	TRANSISTORS, Type 2N1372	8210-1372	01295	2N1372	
Q113	TRANSISTORS, Type 2N1372	8210-1372	01295	2N1372	
Q114	TRANSISTORS, Type 2N1131	8210-1025	96214	2N1131	5960-788-8644
Q116	TRANSISTORS, Type 2N1304	8210-1304	01295	2N1304	5961-892-0800

* Part of Type 1521-P10 or 1521-P11.

**Selected for H_{fe} between 60 and 180.

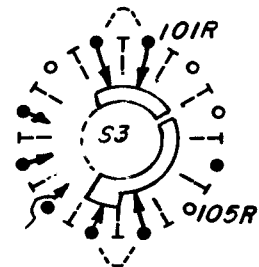
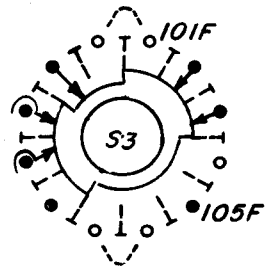
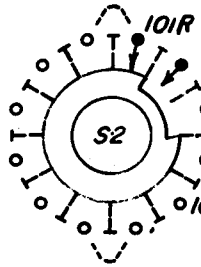
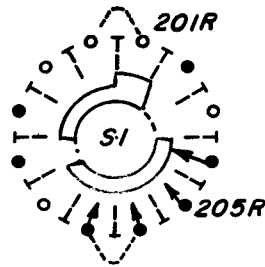
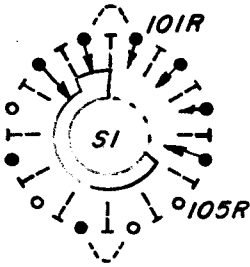
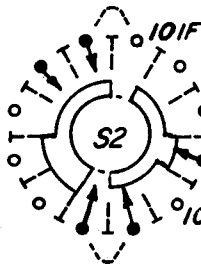
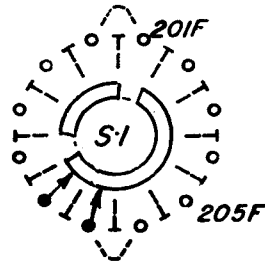
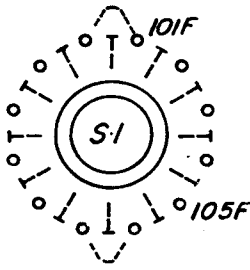

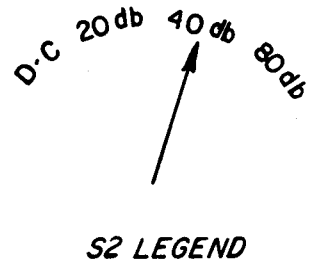
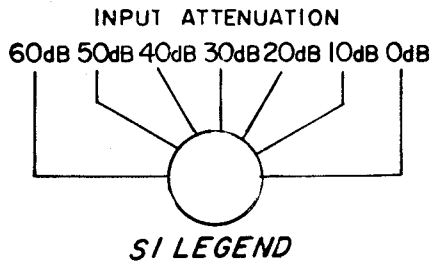
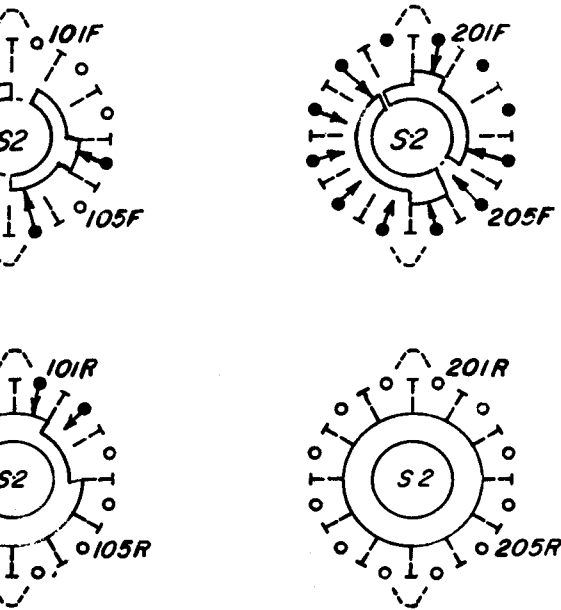

Rotary switch sections are shown as viewed from the panel end of the shaft. The first digit of the contact number refers to the section. The section nearest the panel is 1, the next section back is 2, etc. The next two digits refer to the contact. Contact 01 is the first position clockwise from a strut screw (usually the screw above the locating key), and the other contacts are numbered sequentially (02, 03, 04, etc), proceeding clockwise around the section. A suffix F or R indicates that the contact is on the front or rear of the section, respectively.

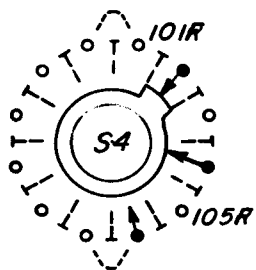
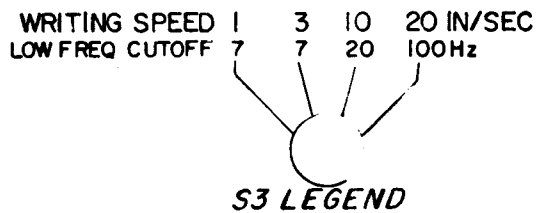
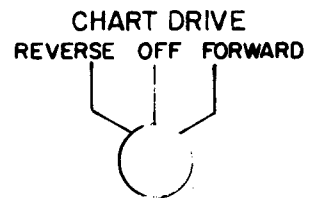
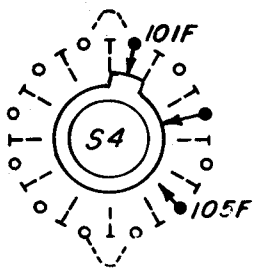
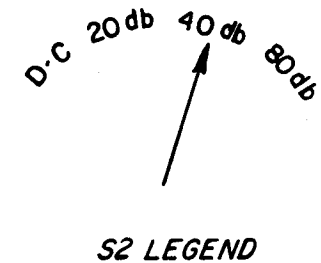
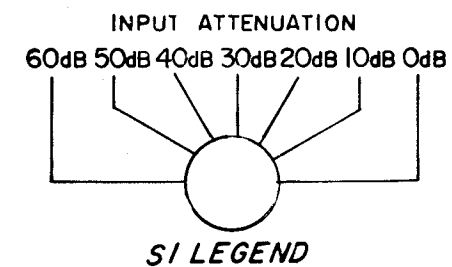
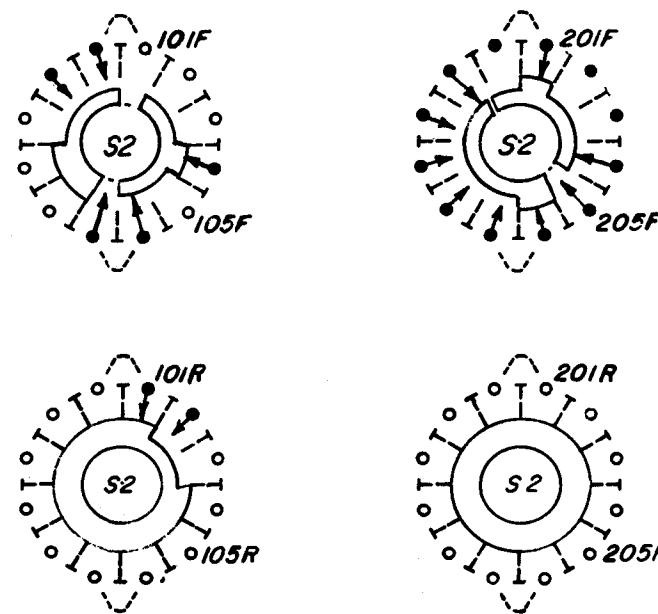
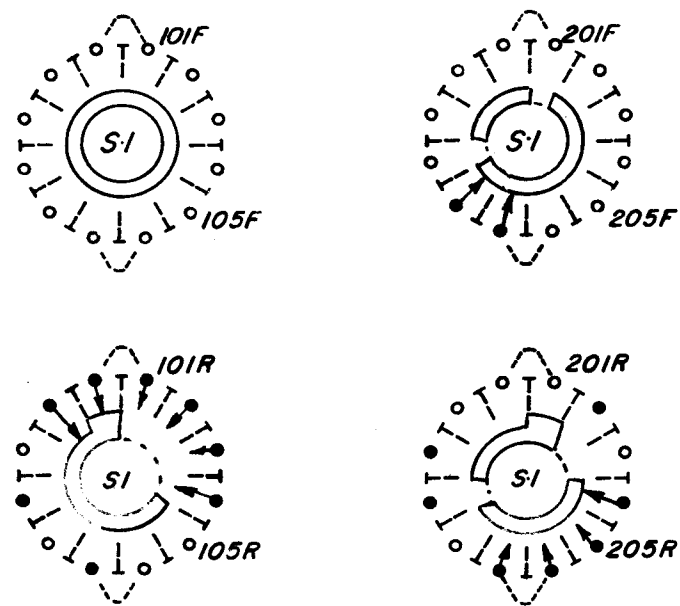

Figure 6.6. Type 1521-B Switching diagram.



Rotary switch sections are shown as viewed from the panel end of the shaft. The first digit of the contact number refers to the section. The section nearest the panel is 1, the next section back is 2, etc. The next two digits refer to the contact. Contact 01 is the first position clockwise from a strut screw (usually the screw above the locating key), and the other contacts are numbered sequentially (02, 03, 04, etc), proceeding clockwise around the section. A suffix F or R indicates that the contact is on the front or rear of the section, respectively.

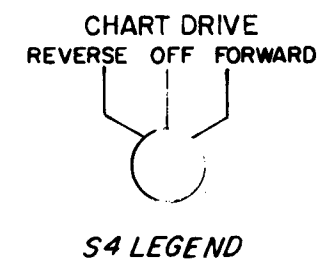
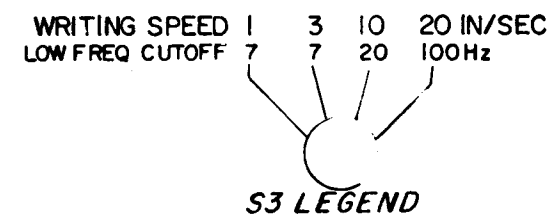
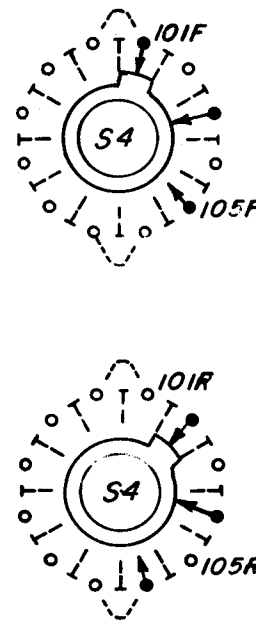
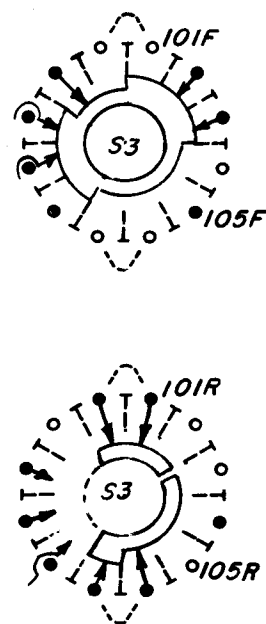
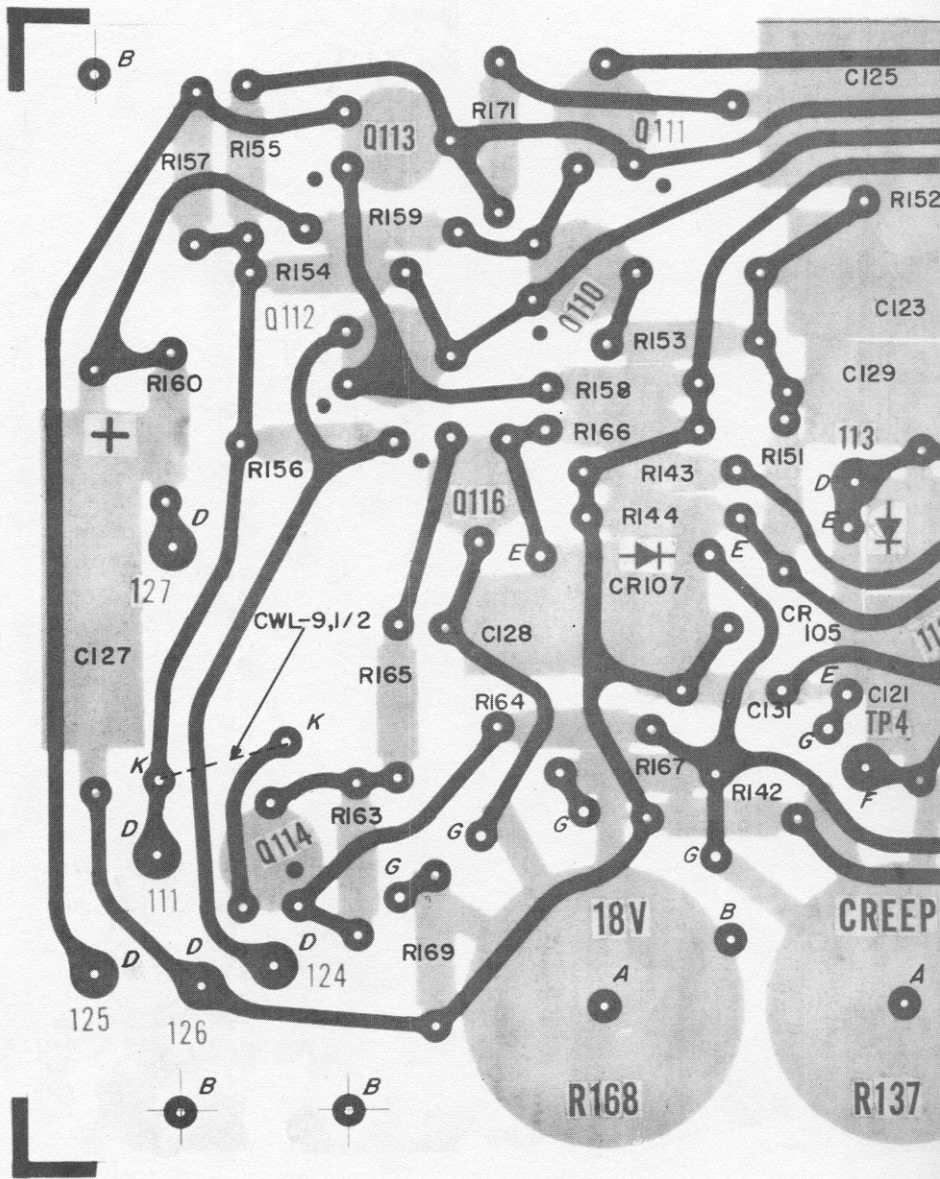
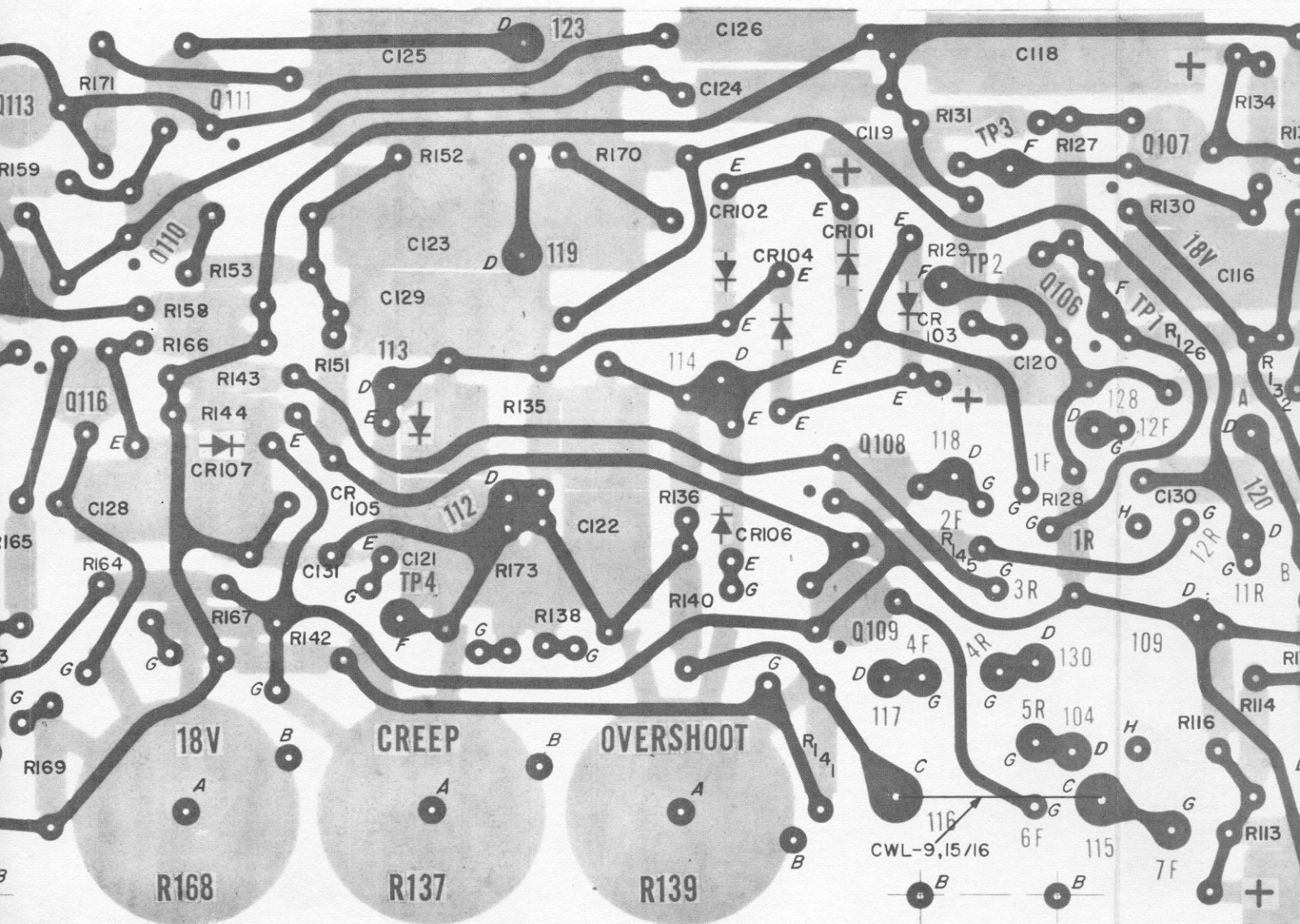

Figure 6.6. Type 1521-B Switching diagram.





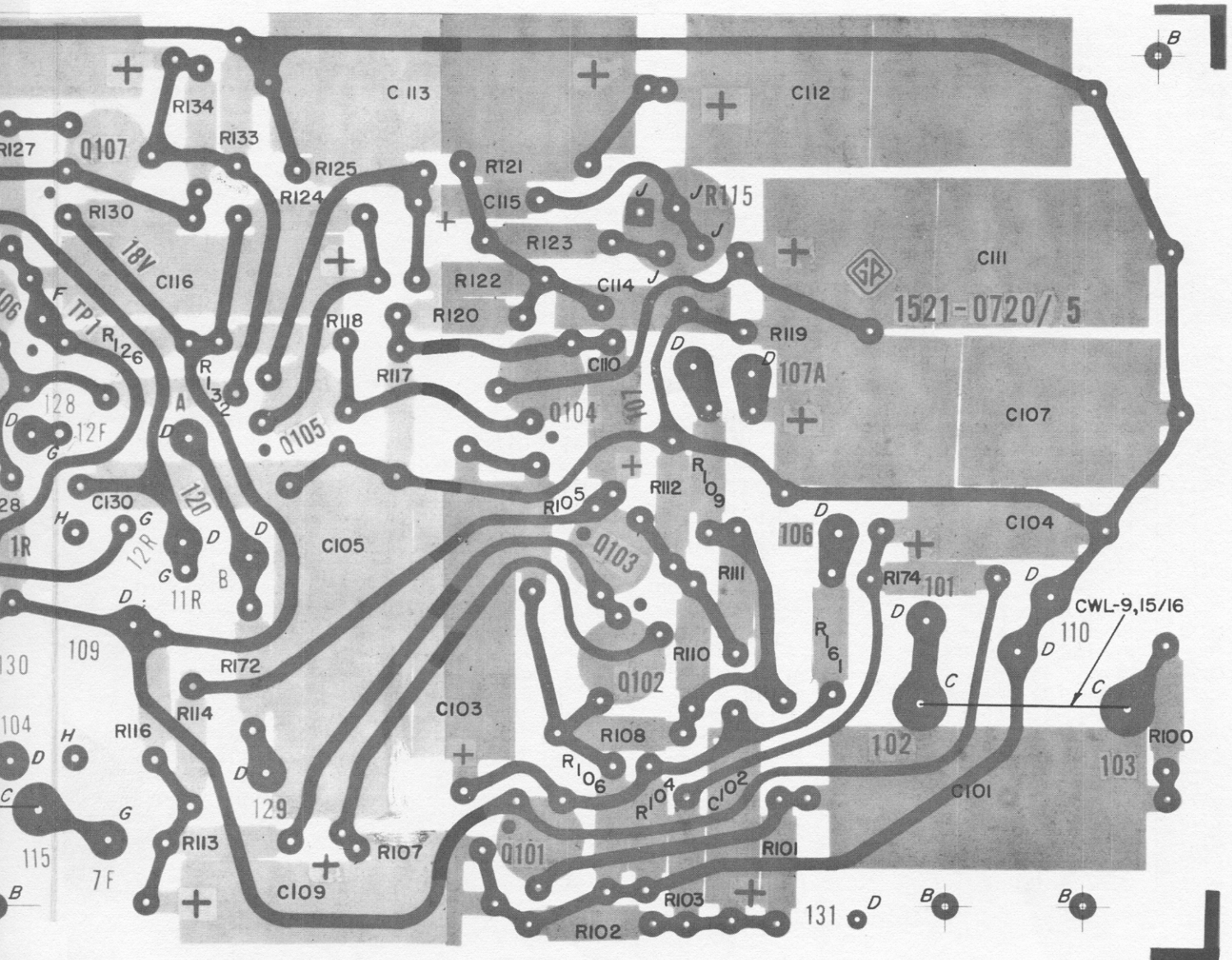

Figure 6.7. Etched-board assembly for the Type 1521-B Graphic Level Recorder (P/N 1521-2721).

NOTE: The board is shown foil-side up. The number appearing on the foil side is *not* the part number. The dot on the foil at the transistor socket indicates the collector lead.

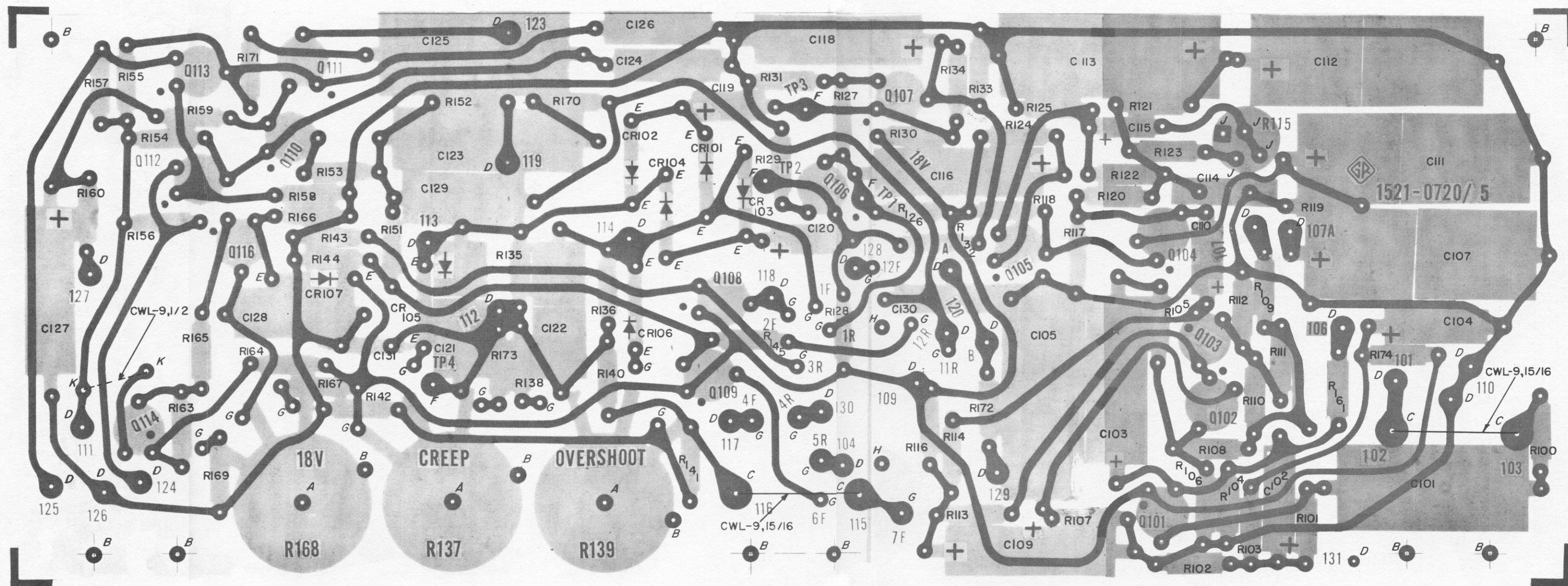

Figure 6.7. Etched-board assembly for the Type 1521-B Graphic Level Recorder (P/N 1521-2721).

NOTE: The board is shown foil-side up. The number appearing on the foil side is *not* the part number. The dot on the foil at the transistor socket indicates the collector lead.

S1 LEGEND

- INPUT ATTENUATION
- 60db ●
 - 50db ●
 - 40db ●
 - 30db ●
 - 20db ●
 - 10db ●
 - 0db ●

S2 LEGEND

- D-C ●
- 20db ●
 - 40db ●
 - 80db ●

S3 LEGEND

- WRITING SPEED 1 ●
- 7 LOV ●
 - 3 ●
 - 10 ●
 - 20 IN/SEC ●
 - 7 ●
 - 20 ●
 - 100Hz ●

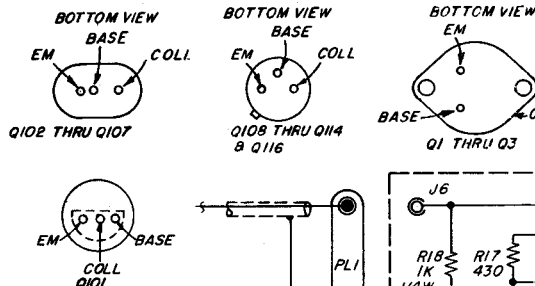
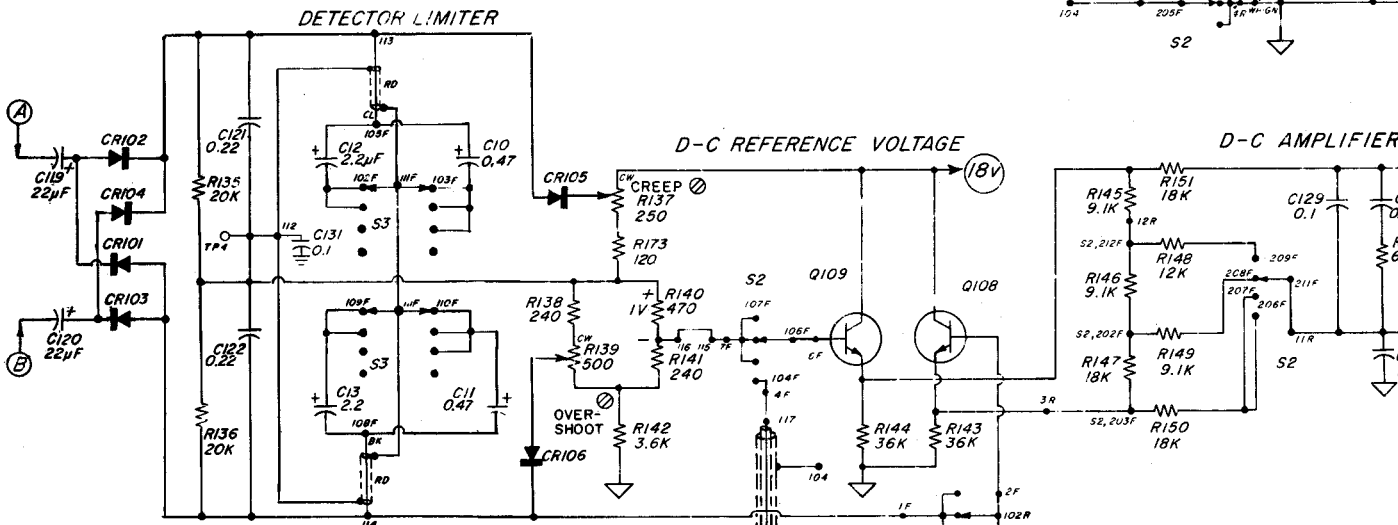
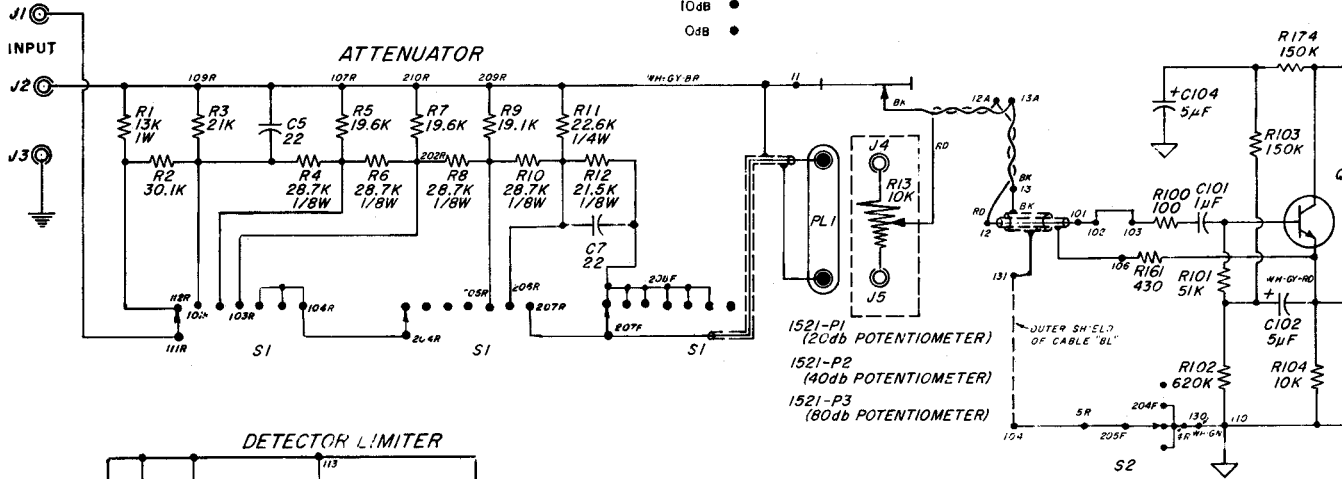

NOTES

T1 FOR 115v OPERATION CONNECT #1 TO #3, #2 TO #4 FOR 230v OPERATION CONNECT #2 TO #3

RESISTORS 1/2 WATT UNLESS OTHERWISE SPECIFIED
RESISTANCE IN OHMS UNLESS OTHERWISE SPECIFIED
CAPACITANCE VALUES ONE & OVER IN PICO FARADS, LESS THAN ONE IN MICROFARADS, UNLESS OTHERWISE SPECIFIED

⊕ SCREWDRIVER ADJUSTMENT

○ KNQB ADJUSTMENT

▽ SIGNAL GND ON ETCHED BOARD

⊥ CHASSIS

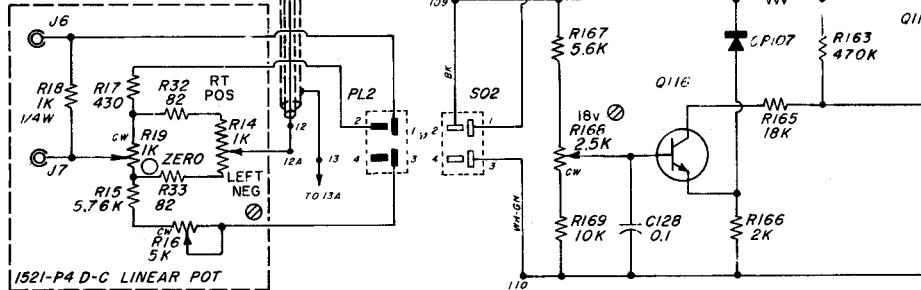

S3 LEGEND

- 7 LOW FREQ CUTOFF
- 7
- 20
- 100Hz

S4 LEGEND
CHART DRIVE

- REVERSE ●
- OFF ●
- FORWARD ●

A-C AMPLIFIER

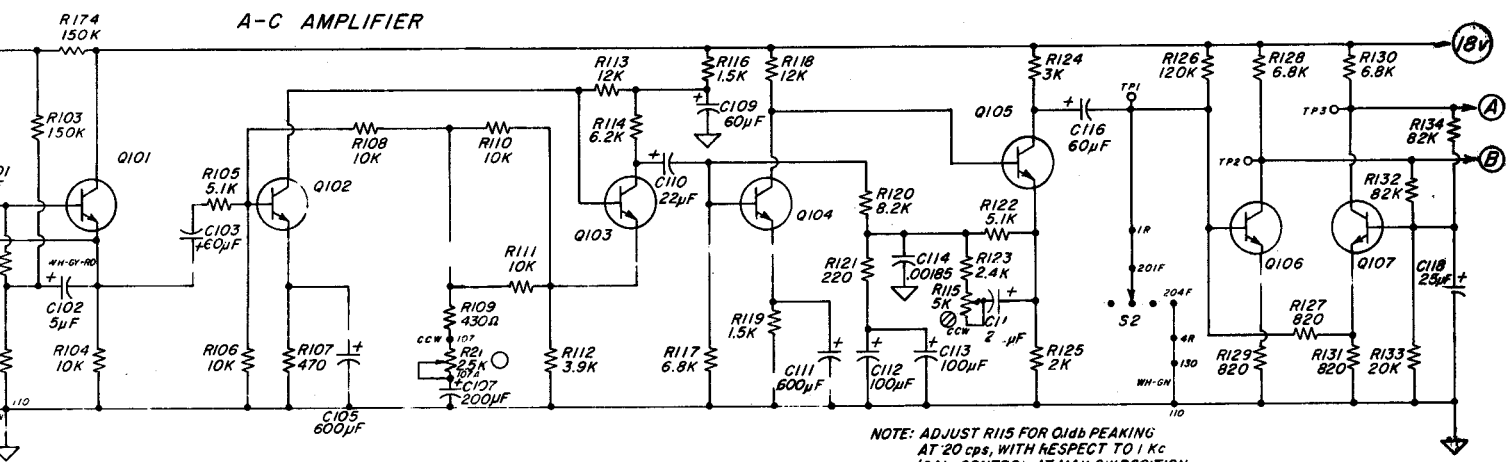

AMPLIFIER

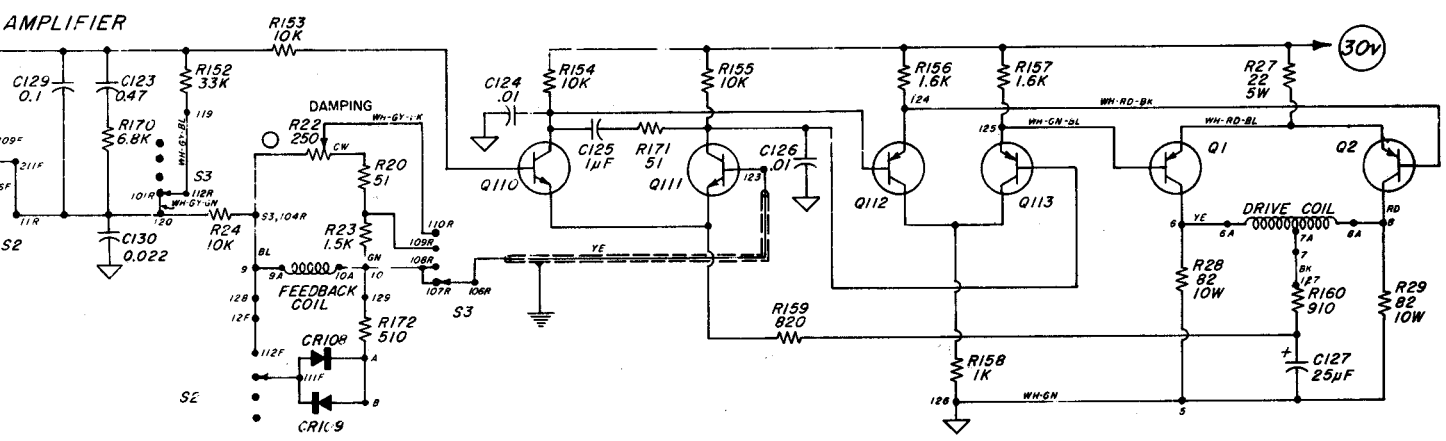

POWER SUPPLY

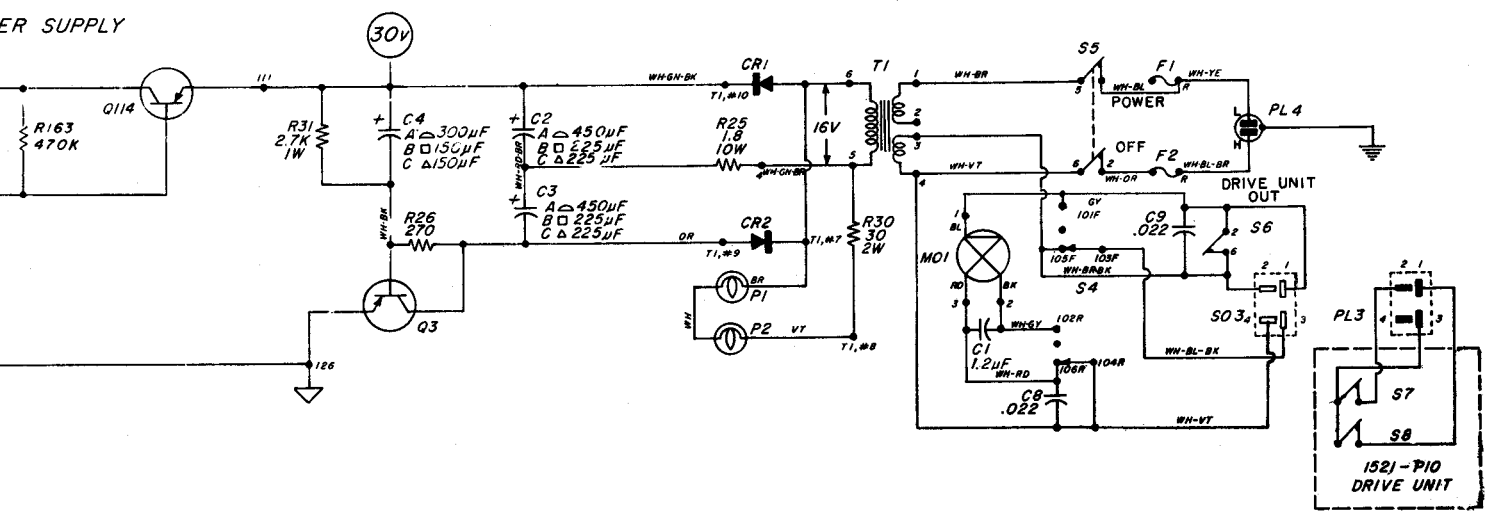

Figure 6.8. Schematic diagram for Type 1521-B Graphic Level Recorder.

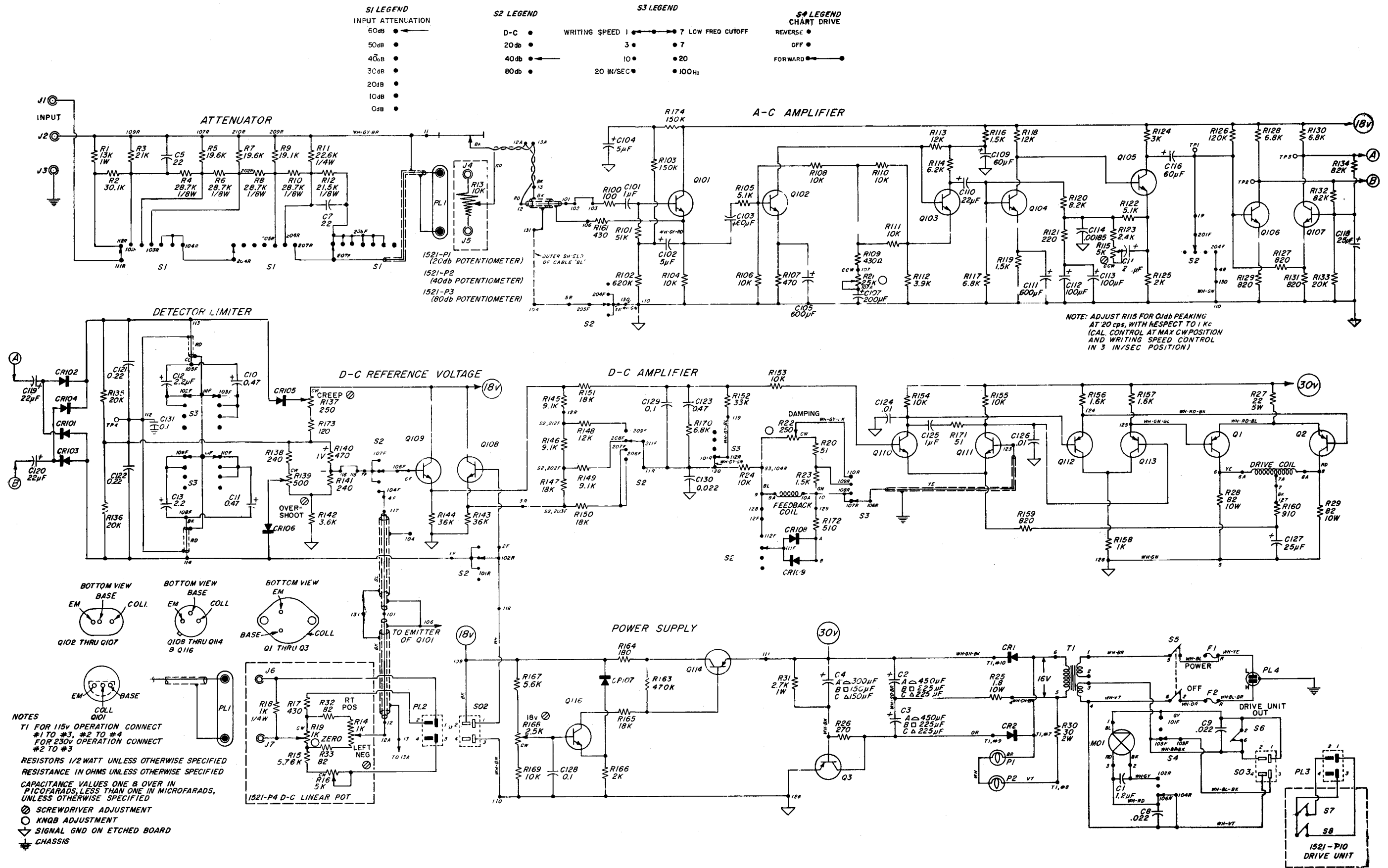
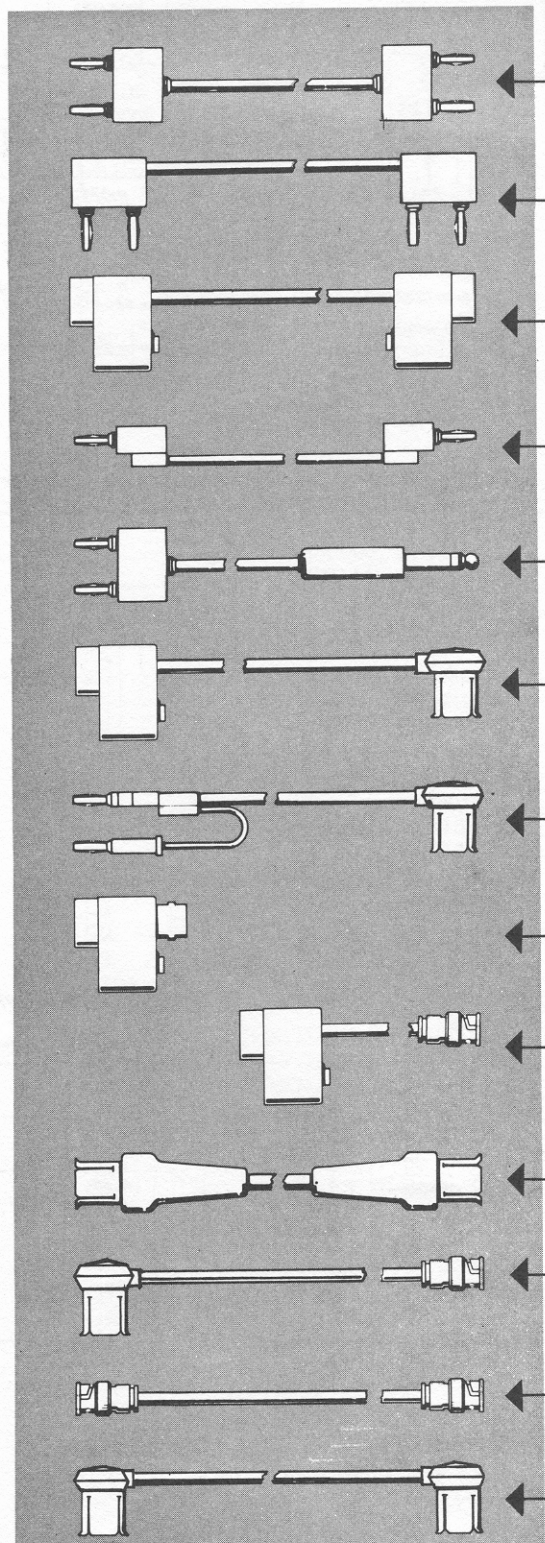

Figure 6.8. Schematic diagram for Type 1521-B Graphic Level Recorder.

Appendix

NOTE: GR874 connectors are 50 Ω and are mechanically sexless; i.e., any two, although identical, can be plugged together.

Patch Cords and Adaptors



TYPE NO.	DESCRIPTION	CATALOG NO.
274-NQ	Double-plug patch cord, in-line 36" long	0274-9860
274-NQM	Double-plug patch cord, in-line 24" long	0274-9896
274-NQS	Double-plug patch cord, in-line 12" long	0274-9861
274-NP	Double-plug patch cord, right-angle 36" long	0274-9880
274-NPM	Double-plug patch cord, right-angle 24" long	0274-9892
274-NPS	Double-plug patch cord, right-angle 12" long	0274-9852
274-NL	Shielded double-plug patch cord, 36" long	0274-9883
274-NLM	Shielded double-plug patch cord, 24" long	0274-9882
274-NLS	Shielded double-plug patch cord, 12" long	0274-9862
274-LLB	Single-plug patch cord, black, 36" long	0274-9468
274-LLR	Single-plug patch cord, red, 36" long	0274-9492
274-LMB	Single-plug patch cord, black, 24" long	0274-9847
274-LMR	Single-plug patch cord, red, 24" long	0274-9848
274-LSB	Single-plug patch cord, black, 12" long	0274-9849
274-LSR	Single-plug patch cord, red, 12" long	0274-9850
1560-P95	Adaptor cable, double-plug to telephone plug, 36"	1560-9695
874-R34	Coaxial patch cord, double plug to GR874, 36" long	0874-9692
874-R33	Coaxial patch cord, two plugs to GR874, 36" long	0874-9690
274-QBJ	Adaptor, shielded double plug to BNC jack	0274-9884
776-A	Patch cord, shielded double plug to BNC plug, 36" long	0776-9701
874-R22A	Coaxial patch cord GR874 to GR874, 36" long	0874-9682
776-B	Patch cord, GR874 (right-angle) to BNC plug, 36" long	0776-9702
776-C	Patch cord, BNC plug to BNC plug, 36" long	0776-9703
776-D	GR874 to GR874, both right-angle, 36" long	0776-9704

AUTOMATIC RECORDING SYSTEMS

Several GR instruments can be used with the Type 1521 Graphic Level Recorder for automatic recording applications. Some of the available systems are described below.

Catalog
Number

1910-A RECORDING WAVE ANALYZER

The 1910-A is particularly useful in analyzing and recording the frequency components present in mechanical vibrations, acoustic signals, and in complex electrical signals including random noise. Its linear frequency scale, 20-Hz to 54-kHz range, three bandwidths (3, 10, and 50 Hz), and 80-dB dynamic range permit higher-order, closely spaced and weak components to be found with ease.

The complete assembly includes the following:

- 1900-A Wave Analyzer, including 1560-P95 Adaptor cable and other accessories
- 1521-B (or -BQ1 for 50-Hz supply) Graphic Level Recorder with 40-dB Potentiometer (1521-9602) and medium-speed motor
- 1521-P3 80-dB Potentiometer (1521-9603)
- 1521-P10B Drive Unit (1521-9467) (installed)
- 1900-P1 Link Unit (1900-9601) (installed)
- 1900-P3 Link Unit (1900-9603)
- Chart Paper, 10 rolls (1521-9464), scale 0-10 kHz
- Chart Paper, 10 rolls (1521-9465), scale 0-50 kHz

Accessories Available: 1560-P40H Preamplifier and Power Supply Set; choice of vibration pickups or microphones.

Mounting: Rack-Bench Cabinets; includes end frames for bench use and supports for rack mounting.

Dimensions (width x height x depth): Bench, 19 x 25¼ x 15¼ in. (485 x 645 x 390 mm); rack, 19 x 24½ x 13¼ in. (485 x 625 x 340 mm).

Weight: Net, 116 lb (53 kg); shipping, 227 lb (104 kg).

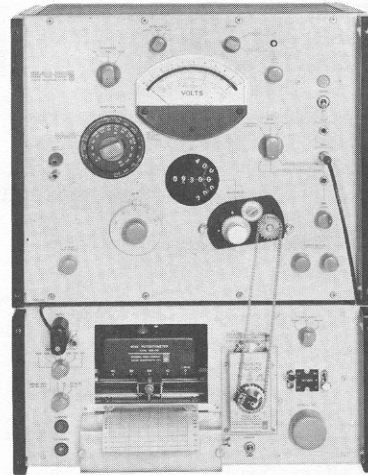

1910-A Recording Wave Analyzer, (for 60-Hz supply)
1910-AQ1 Recording Wave Analyzer, (for 50-Hz supply)

1910-9701
1910-9494

1911-A RECORDING SOUND AND VIBRATION ANALYZER

This assembly will generate continuous frequency plots of the 1/3- or 1/10-octave spectrum of sound and vibration signals over the range of 4.5 Hz to 25 kHz. Thus 1/3-octave measurements can be made in accordance with several common military and industrial noise-control specifications. While the third-octave bandwidth is convenient for testing compliance to a specification for maximum allowable noise or vibration level, the 1/10-octave bandwidth permits identification of individual frequency components, leading to their reduction or elimination. The analyzer will accept signals from a sound-level meter, vibration meter, or other stable amplifier, or directly from a microphone or vibration pickup.

The 1911-A consists of the following:

- 1564-A Sound and Vibration Analyzer, rack model
- 1521-B (or -BQ1 for 50-Hz supply) Graphic Level Recorder with 40-dB Potentiometer (1521-9602) and medium-speed motor
- 1521-P10B Drive Unit (1521-9467)
- 1521-P15 Link Unit (1521-9615), with 16-tooth sprocket installed (standard 24-tooth sprocket also included)
- Chart Paper, 10 rolls (1521-9469), calibrated 2.5-25 normalized, logarithmic
- Adaptor Cable, double plug to offset phone plug.

Accessories Available: 1560-P40K Preamplifier and Microphone Set; 80-dB potentiometer; choice of vibration pickups.

Mounting: Completely assembled with end frames for bench use. Hardware for rack mounting is supplied.

Dimensions (width x height x depth): 19¾ x 31¼ x 15¾ in. (500 x 800 x 400 mm).

Weight: Net, 76 lb (35 kg); shipping, 155 lb (71 kg).

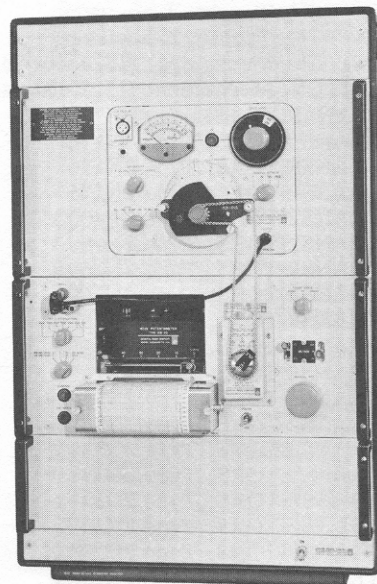

1911-A Recording Sound and Vibration Analyzer (for 60-Hz supply)
1911-AQ1 Recording Sound and Vibration Analyzer (for 50-Hz supply)

1911-9701
1911-9494

1912 THIRD-OCTAVE RECORDING ANALYZER

The 1912 will make chart records of stepped third-octave analyses of sound and vibration as called for in such standards as Military Standard-740B(SHIPS), ASHRAE 36A-63, and others. In stepped analysis, the analyzer steps from frequency to frequency and dwells a specified time at each while the recorder chart paper feeds continuously. The result is a synchronized, calibrated plot of time-averaged levels in each third-octave band for ease of analysis.

Frequency can also be swept continuously, giving more detailed information than when stepped.

The 1912 is supplied completely assembled in a cabinet and includes a storage drawer and a system power control, which switches the analyzer battery supply as well as the ac line.

The 1912 includes the following:

- 1564-A Sound and Vibration Analyzer, rack model
- 1564-P1 Dial Drive
- 1521-B Graphic Level Recorder with 40-dB Potentiometer (1521-9602) and medium-speed motor
- Chart Paper, 10 rolls (1521-9460), for stepped analysis

Accessories Available: 1560-P40K Preamplifier and Microphone Set, Chart Paper 1521-9469 for continuous-mode analysis, 80-dB potentiometer, choice of GR microphones and vibration pickups for direct vibration or acoustic analysis.

Mounting: Assembled in cabinet.

Dimensions (width x height x depth): 19¾ x 31¼ x 18½ in. (500 x 800 x 470 mm).

Weight: Net, 115 lb (53 kg); shipping (est), 215 lb (100 kg).

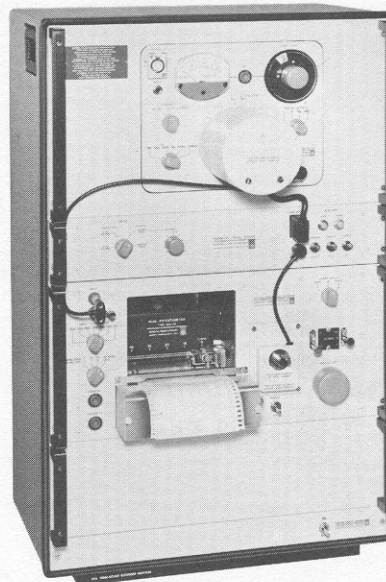

1912 Third-Octave Recording Analyzer
(for 115-V, 60-Hz supply)

1912-9700

1913 RECORDING WAVE ANALYZER — 1% Bandwidth

This constant-percentage-bandwidth recording analyzer will make high-resolution spectrum plots from 20 Hz to 20 kHz. It is easy to use, having automatic range switching and few controls. Wide dynamic range and the 80-dB potentiometer reduce the need to change sensitivity manually to accommodate widely varying amplitudes. Narrow bandwidth permits separation of closely spaced low frequencies without forfeiting high-frequency resolution; typically, the fiftieth harmonic can be identified.

The 1913 is supplied assembled and includes a storage drawer and system power control, which switches the analyzer battery supply as well as the ac line.

The 1913 includes the following:

- 1568-A Wave Analyzer, rack model, and accessories
- 1521-B (or -BQ1 for 50-Hz supply) Graphic Level Recorder with 40-dB Potentiometer (1521-9602) and medium-speed motor
- 1521-P3 80-dB Potentiometer (1521-9603)
- 1521-P10B Drive Unit (1521-9467)
- 1521-P15 Link Unit (1521-9615), with 16-tooth sprocket installed (standard 24-tooth sprocket also included)
- Chart Paper, 10 rolls (1521-9475), scale 2-20 log, normalized

Accessories Available: 1560-P40J Preamplifier and Adaptor Set.

Mounting: Assembled in cabinet.

Dimensions (width x height x depth): 19¾ x 31¼ x 15¾ in. (500 x 800 x 400 mm).

Weight: Net, 100 lb (46 kg); shipping (est), 200 lb (92 kg).

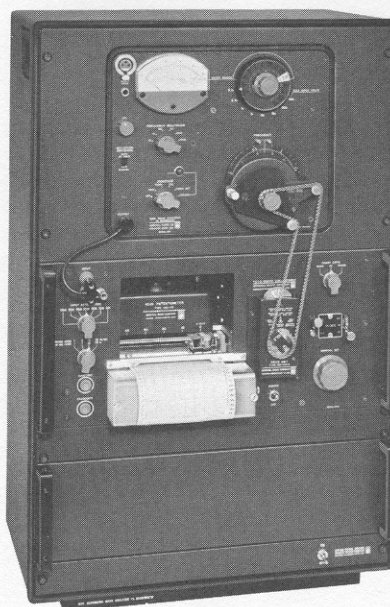

1913 Recording Wave Analyzer, 1% Bandwidth
for 115-V, 60-Hz supply
for 230-V, 50-Hz supply

1913-9700
1913-9701

1350-A GENERATOR- RECORDER ASSEMBLY

Constant generator output and uniform recorder response make this an excellent assembly for measuring the response of filters, attenuators, networks, loud-speakers, amplifiers, microphones, transducers, and complete acoustic systems.

The blank parts on the chart paper correspond to the length of the blank portion on the generator dial so that many charts can be recorded with complete synchronization of the chart and the dial frequency.

The complete assembly includes the following:

1304-B Beat-Frequency Audio Generator with accessories, end frames and rack supports.

1521-B Graphic Level Recorder with accessories (including a 40-dB potentiometer), 1521-P19 motor, end frames and rack supports.

1521-9427 Chart Paper, 10 rolls

274-NP Patch Cord

1521-P10B Drive Unit

1521-P15 Link Unit

1521-P16 Sprocket Kit

1560-P95 Adaptor Cable

1304-P1 Muting Switch

Power Required: 105 to 125 or 210 to 250 V, 60 or 50 Hz, 135 W.

Dimensions (width x height x depth): 19 x 16½ x 15¼ in. (485 x 420 x 390 mm).

Weight: Net, 89 lb (41 kg); shipping, 165 lb (76 kg).

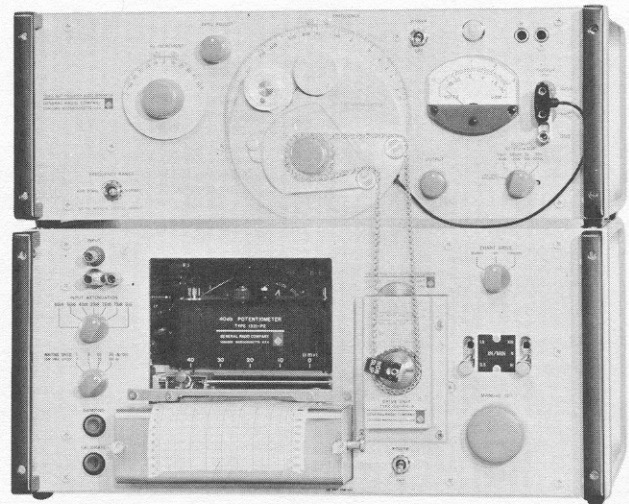

Generator-Recorder Assembly
1350-A, for 60-Hz supply
1350-AQ1, for 50-Hz supply

Catalog Number
1350-9701
1350-9494

EQUIVALENT SYSTEMS

As an alternative to purchasing an assembled Automatic Recording System, as previously described, a functionally-equivalent system can be assembled, using standard bench instruments and appropriate accessories. The equipment required for this purpose can be selected from the table of BASIC EQUIPMENT REQUIRED FOR 1521 RECORDING SYSTEMS/APPLICATIONS.

The table does not list many standard accessories that are required because they are normally supplied

with the instruments. Other accessories, such as system cabinets and System Power Control units, are also not listed because they are usually supplied only as part of the complete, GR-assembled system.

Investigate both types of systems. If a significant portion of the necessary equipment is already on hand and available for use, it may be economical to build an equivalent system using the equipment listed in the table. If not, the overall cost may be prohibitive and the complete GR-assembled system may be the better choice.

**BASIC EQUIPMENT REQUIRED FOR
1521 RECORDING SYSTEMS/APPLICATIONS**

Instruments and Accessories	Recording System/Application				
	Beat-Frequency Audio Generator 1304-A	Continuous Sound and Vibration Analysis (1/3 and 1/10 octave) 1564-A	Stepped Third- Octave Analysis 1564-A	Recording Wave Analyzer (1% Bandwidth) 1568-A	Recording Wave Analyzer 1900-A
INSTRUMENTS					
1521-B Graphic Level Recorder:	X	X	X	X	X
* { 40-dB Potentiometer, 1521-P2	X	X	X	X	X
* { High-Speed Motor, 1521-P19	X	—	—	—	—
* { Adaptor Cable, 1560-P95	X	—	—	—	X
1304-A Beat-Frequency Generator	X	—	—	—	—
1564-A Sound and Vibration Analyzer	—	X	X	—	—
1568-A Wave Analyzer	—	—	—	X	—
1900-A Wave Analyzer	—	—	—	—	X
ACCESSORIES					
80-dB Potentiometer	—	—	1521-P3	1521-P3	1521-P3
Medium-Speed Motor	—	1521-P23	1521-P23	1521-P23	1521-P23
Drive Unit	1521-P10B	1521-P10B	—	1521-P10B	1521-P10B
Muting Switch	1304-P1	—	—	—	—
Link Unit	1521-P15	1521-P15	—	1521-P15	1900-P3
Sprocket Kit	1521-P16	1521-P16	—	—	—
Dial Drive	—	—	1564-P1	—	—
Chart Paper	1521-9427	1521-9469	1521-9469 1521-9460	1521-9475	1521-9464 1521-9465
Adaptor Cable Assembly	—	1560-2141	—	1560-2145	—
Patch Cord	274-NP	—	—	—	—
GR Handbook of Noise Measurement	—	Form 811G	Form 811G	Form 811G	—

* Accessories normally supplied with 1521-B recorder.

GENERAL RADIO

WEST CONCORD, MASSACHUSETTS 01781
617 369-4400

SALES AND SERVICE

ATLANTA	404 633-6183	DENVER	303 447-9225	ROCHESTER	315 394-2037
*BOSTON	617 646-0550	DETROIT	313 261-1750	PHILADELPHIA	215 646-8030
BRIDGEPORT	203 377-0165	GREENSBORO	919 288-4316	SAN DIEGO	714 232-2727
*CHICAGO	312 992-0800	HOUSTON	713 622-7007	*SAN FRANCISCO	415 948-8233
*CLEVELAND	216 886-0150	HUNTSVILLE	800 241-5122	SEATTLE	206 GL4-7545
COCOA BEACH	800 241-5122	INDIANAPOLIS	317 636-3907	SYRACUSE	315 454-9323
*DALLAS	214 637-2240	*LOS ANGELES	213 469-6201	*WASHINGTON,	
DAYTON	513 434-6979	*NEW YORK	(NY) 212 964-2722 (NJ) 201 943-3140	BALTIMORE	301 946-1600

INTERNATIONAL DIVISION

WEST CONCORD, MASSACHUSETTS 01781, USA

*GENERAL RADIO COMPANY (OVERSEAS)

Helenastrasse 3, CH-8034, Zürich 34, Switzerland

AUSTRALIA Warburton Frankl Industries Pty. Ltd. Sydney, Melbourne, Brisbane, Adelaide	JAPAN Midoriya Electric Co., Ltd. Tokyo	REPUBLIC OF SOUTH AFRICA G. H. Langer & Co., Ltd. Johannesburg	AUSTRIA Dipl. Ing. Peter Marchetti Wien	FRANCE Ets Radiophon Paris, Lyon Radiophon Corporation New York	NORWAY Gustav A. Ring A/S Oslo
CANADA — * General Radio Canada Limited Toronto, Montreal, Ottawa	KOREA M-C International San Francisco, Seoul, Korea	SOUTH and CENTRAL AMERICA Ad. Aurjema, Inc. New York	BELGIUM Groenpol-Belgique S. A. Bruxelles	GERMANY General Radio GmbH München Norddeutsche Vertretung Dr.-Ing. Nüsslein Wedel	SWEDEN Firma Johan Lagercrantz KB Solna
DEMOCRATIC REPUBLIC OF THE CONGO Rudolph-Desco Co., Inc. New York	MALAYSIA and SINGAPORE Vanguard Company Kuala Lumpur, Malaysia	TAIWAN Heighen Scientific Co., Ltd. Taipei	DENMARK Semler & Matthiessen København Ø	GREECE Marios Dalleggio Athens	SWITZERLAND Seyffer & Co. AG Zürich
INDIA Motwane Private Limited Bombay, Calcutta, Lucknow, Kanpur, New Delhi, Bangalore, Madras	MEXICO Fredin S.A. Mexico, D.F.	THAILAND G. Simon Radio Company Ltd. Bangkok	EIRE General Radio Company (Overseas) General Radio Company (U.K.) Limited	ISRAEL Electronics Ltd. Tel Aviv	UNITED KINGDOM * General Radio Company (U.K.) Limited Bourne End, Buckinghamshire
	NEW ZEALAND W. & K. McLean Limited Auckland	TURKEY Mevag Engineering, Trading and Industrial Corporation Istanbul	FINLAND Into O/Y Helsinki	ITALY Ing. S. & Dr. Guido Belotti Milano, Genova, Roma, Napoli	YUGOSLAVIA Sanford de Brun Wien, Österreich
	PHILIPPINES T. J. Wolff & Company Makati, Rizal			NETHERLANDS Groenpol Groep Verkoop Amsterdam	
	PORTUGAL and SPAIN Ad. Aurjema, Inc. New York, Madrid, Lisbon				

* Repair services are available at these offices.

PRINTED IN U.S.A.

GENERAL RADIO
WEST CONCORD, MASSACHUSETTS 01781